

# Tricky Lowercase Letters

a letter recognition activity



by  
**Shanna Behrens**  
  
**ALL ABOUT Reading**

# Tricky Lowercase Letters

---

Some letters, like lowercase A, G, Q, T and Y, have various forms. The typewritten forms of these letters look different from the handwritten form, which might confuse your child. These fun activities are designed to help your child become familiar with all forms of these tricky letters. Let's get started!



---

## Contents

---

### Lowercase Letter A

- Instructions. . . . . 3
- Color Version . . . . . 4-7
- Black and White Version . . . . . 8-11

### Lowercase Letter G

- Instructions. . . . . 12
- Color Version . . . . . 13-16
- Black and White Version . . . . . 17-20

### Lowercase Letter Q

- Instructions. . . . . 21
- Color Version . . . . . 22-25
- Black and White Version . . . . . 26-29

### Lowercase Letter T

- Instructions. . . . . 30
- Color Version . . . . . 31-34
- Black and White Version . . . . . 35-38

### Lowercase Letter Y

- Instructions. . . . . 39
- Color Version . . . . . 40-43
- Black and White Version . . . . . 44-47

# Tricky Letters: Lowercase A

## Prepare the Activities

1. Print pages 4-7 (color) or 8-11 (black-and-white).
2. Cut out the pieces from page 5 (color) or page 9 (black-and-white). Mix up the pieces and set aside.
3. For these activities, you'll need the following: 4 crayons (red, brown, green, and blue), a marker or pen, and a red dot marker or crayon.



## How to Play “Spot and Color”

Have your child color the letters with the corresponding color from the color key. Note that all forms of lowercase letter A will be colored the same color.

## How to Play “Collect the Apples”

Using a marker or pen, have your child navigate through the maze by following the apples marked with the different forms of lowercase letter A.

## How to Play “Caterpillar Match”

Using the unique designs on the caterpillar bodies as a guide, have your child put the caterpillars together, matching the front and back halves.

## How to Play “Dot the Apple Tree”

Have your child fill in the lowercase letter A dots with a red dot marker or crayon. Your child may wish to fill in all the other dots with a different color.

# Spot and Color

Color the lowercase letters as indicated in the color key below.

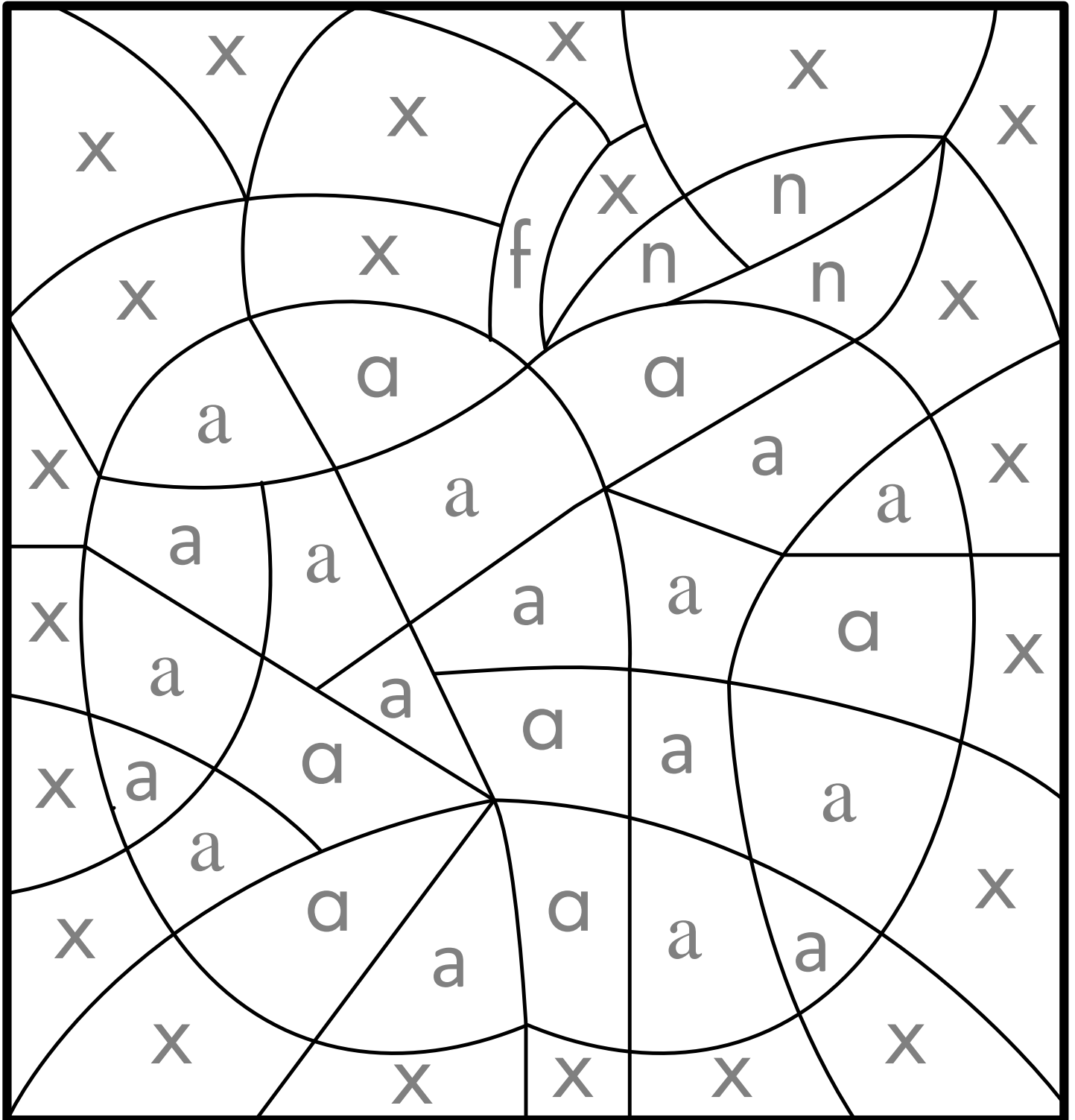



# Collect the Apples

Make your way from the apple tree to the basket by collecting only apples with the letter A on them.

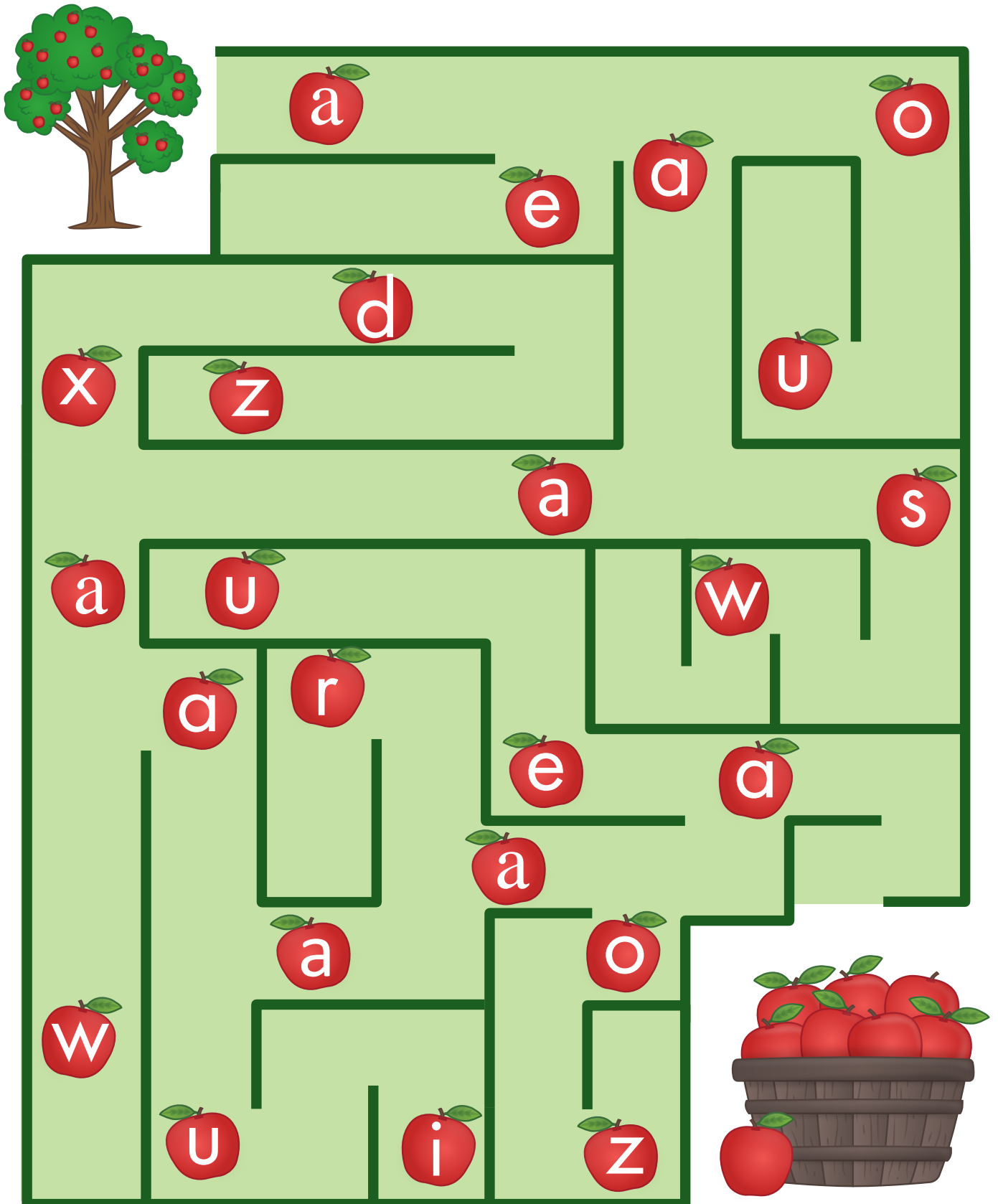

# Caterpillar Match

Cut out the caterpillar pieces and mix them up.

Put the caterpillars together, matching the front and back ends.

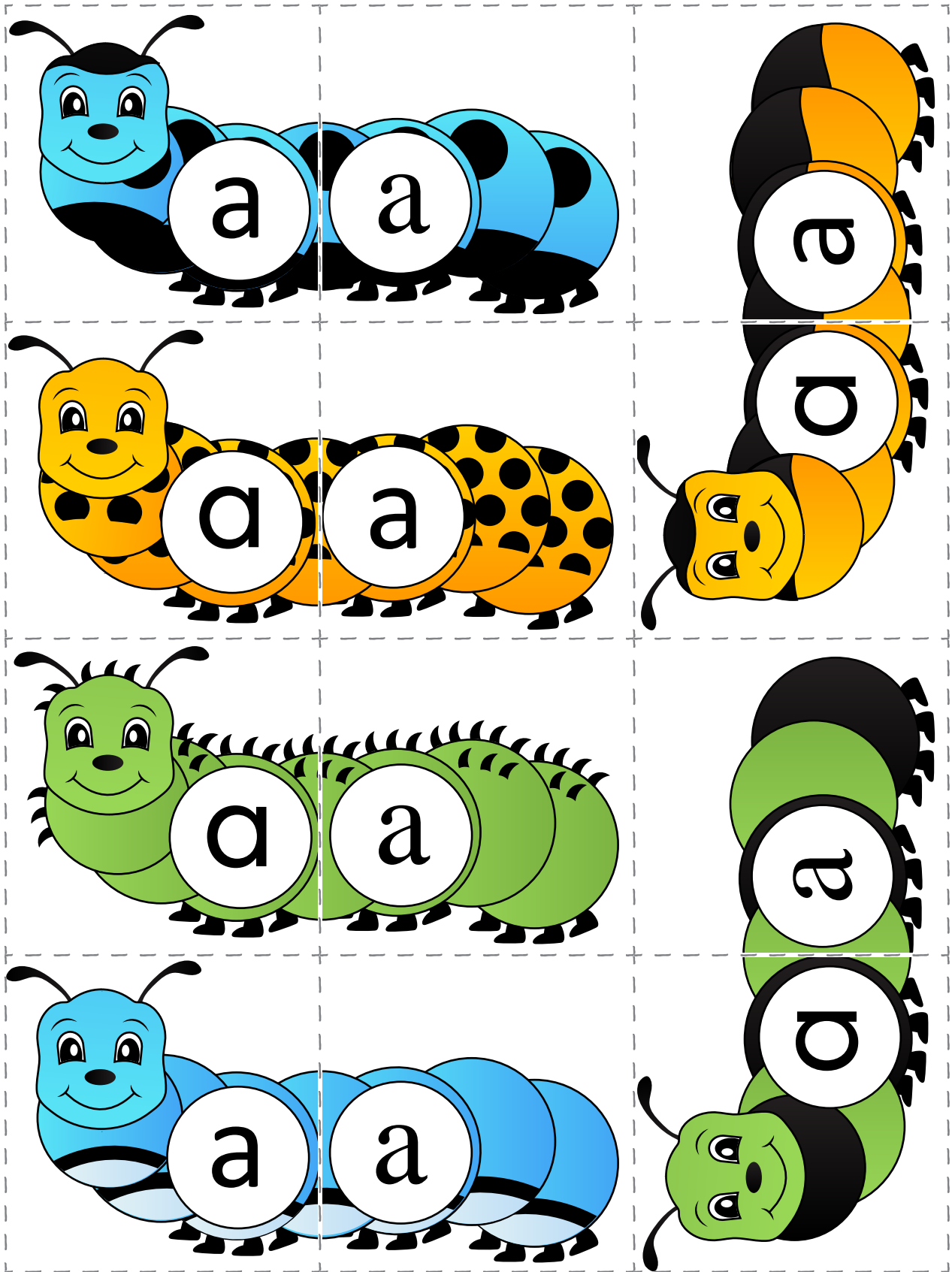

# Dot the Apple Tree

Add some apples to the tree by using a red dot marker or crayon to fill in the letter A dots.

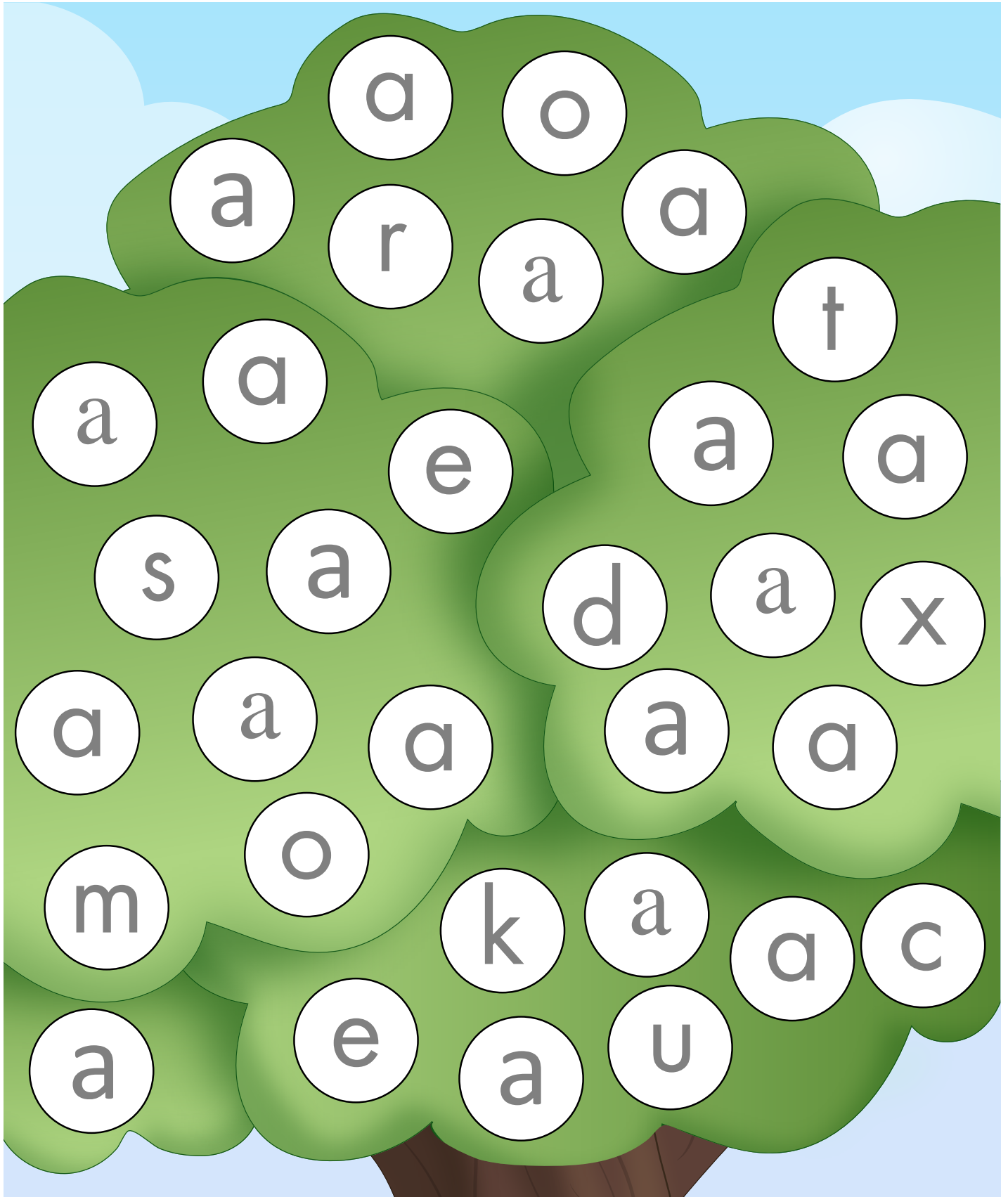

# Spot and Color

Color the lowercase letters as indicated in the color key below.

**a** 

**f** 

**n** 

**x** 

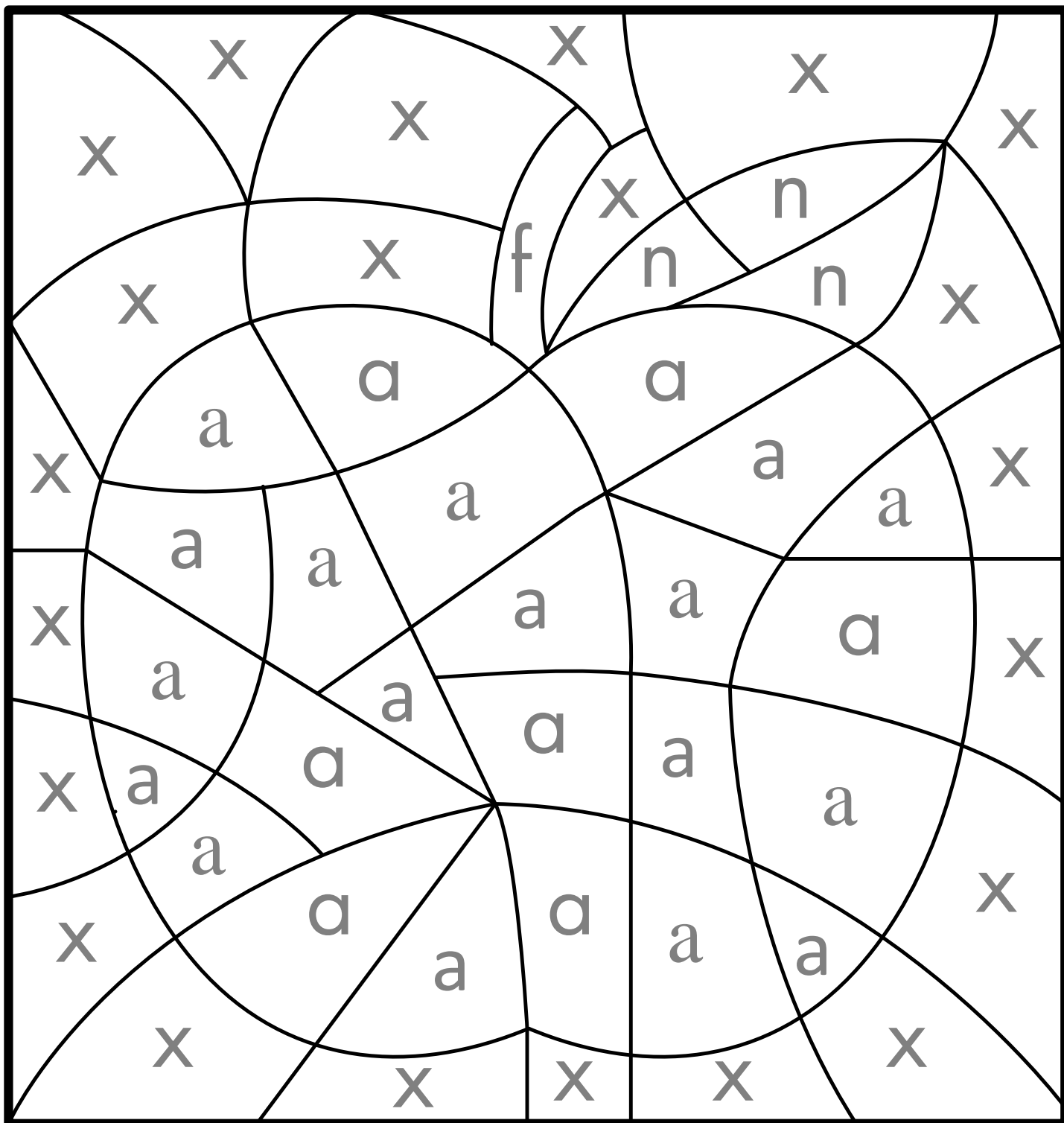

# Collect the Apples

Make your way from the apple tree to the basket by collecting only apples with the letter A on them.

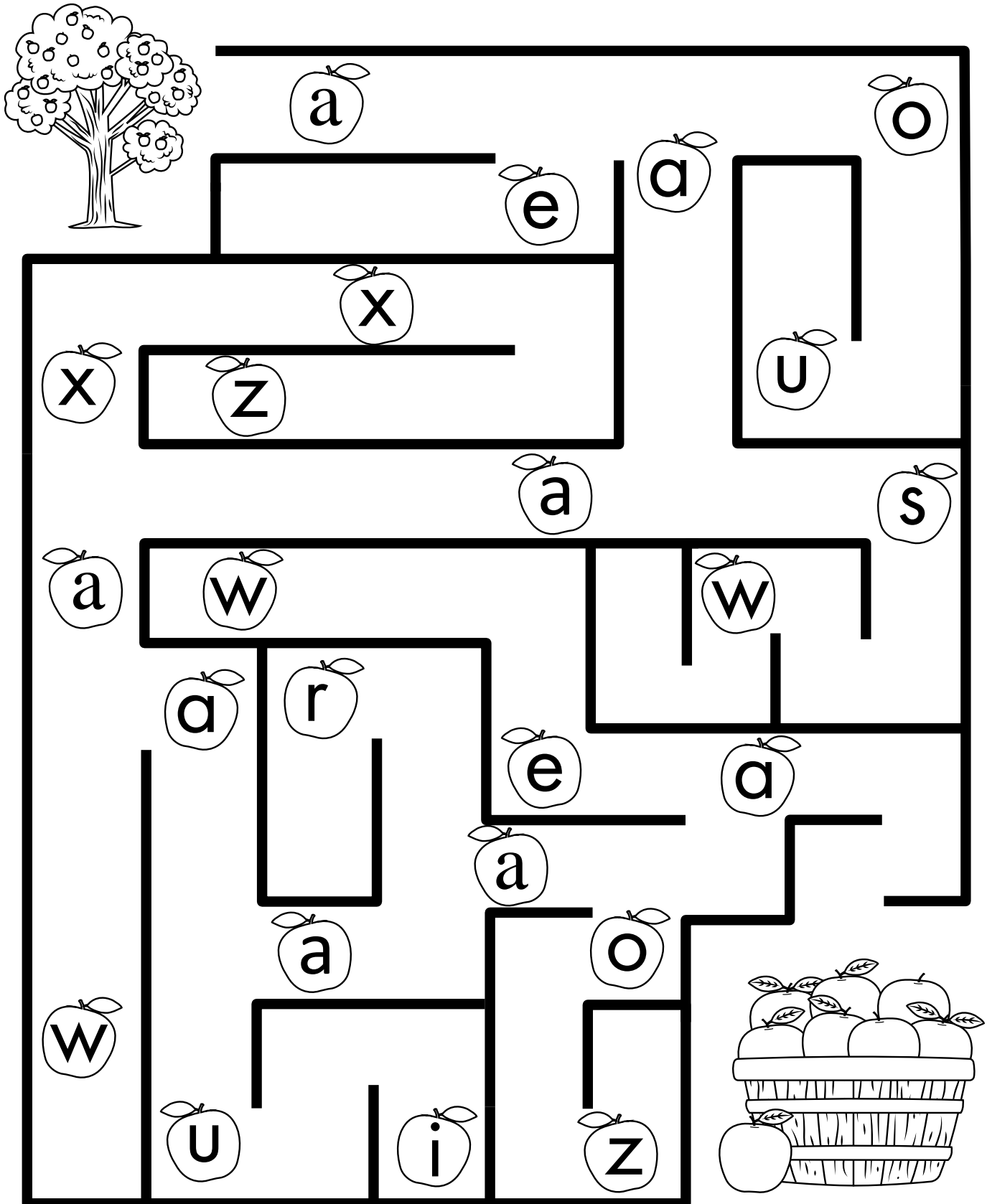

# Caterpillar Match

Cut out the caterpillar pieces and mix them up.

Put the caterpillars together, matching the front and back ends.

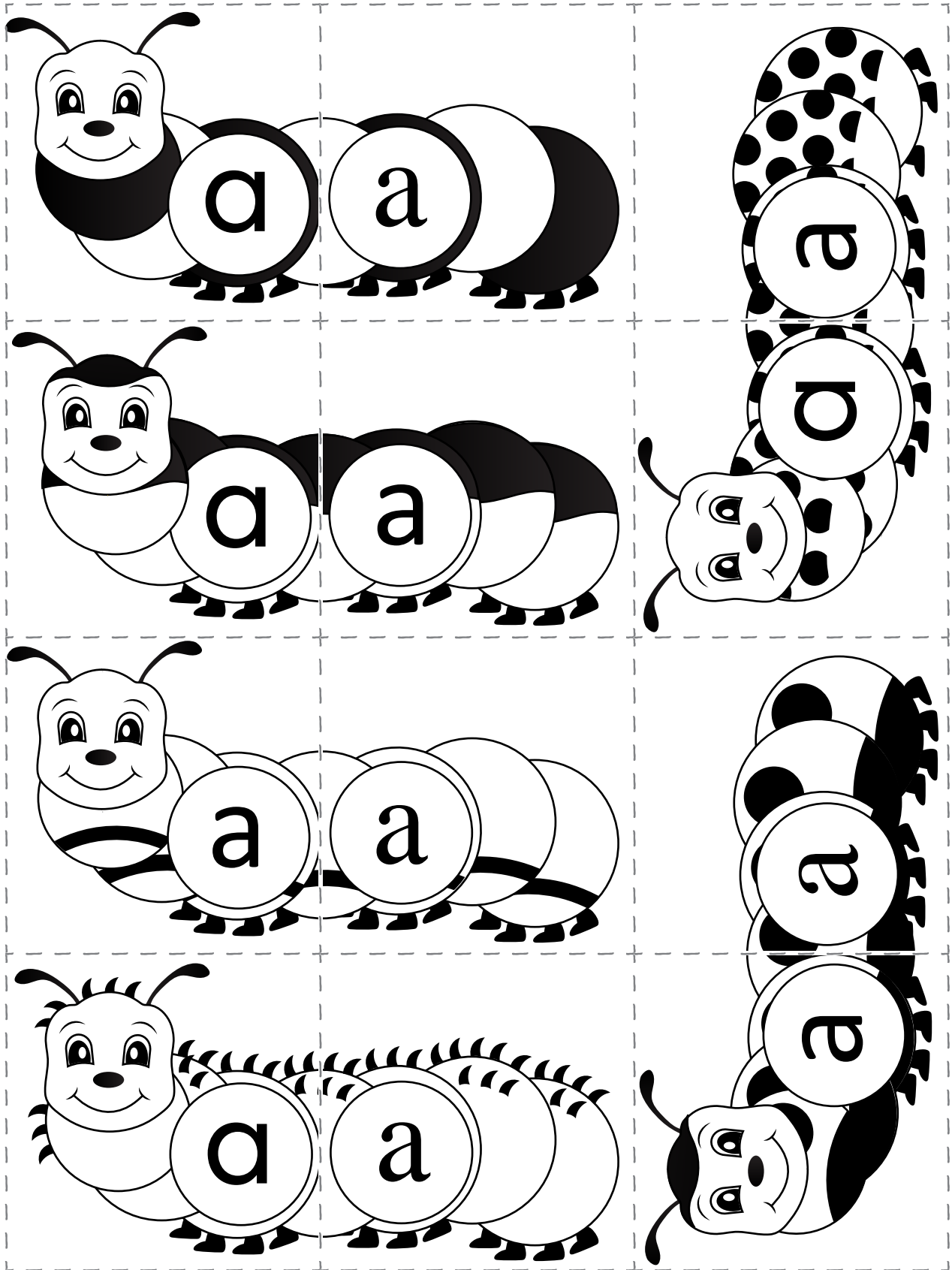



# Dot the Apple Tree

Add some apples to the tree by using a red dot marker or crayon to fill in the letter A dots.

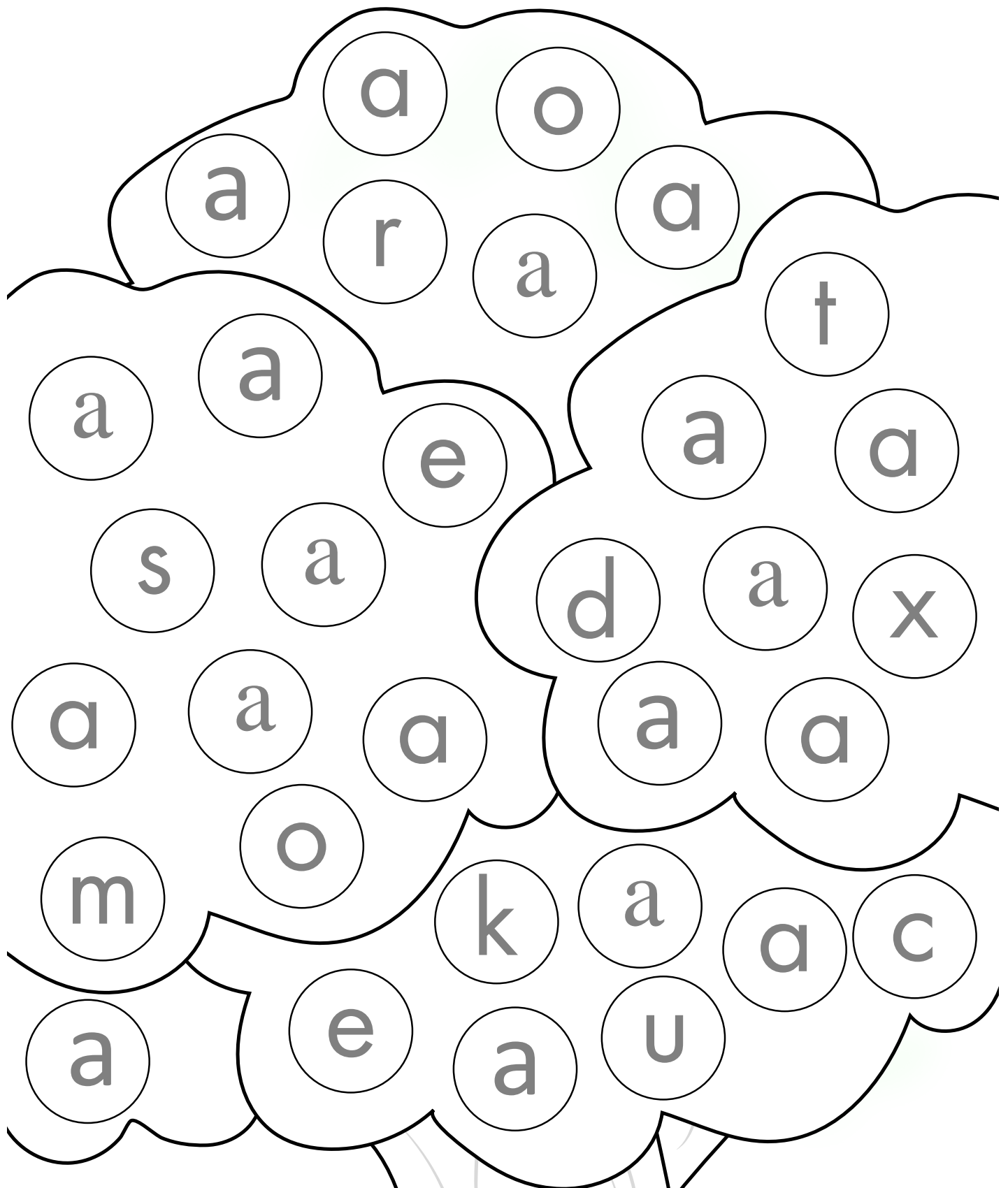

# Tricky Letters: Lowercase G

## Prepare the Activities

1. Print pages 13-16 (color) or 17-20 (black-and-white).
2. Cut out the pieces from page 15 (color) or page 19 (black-and-white). Mix up the pieces and set aside.
3. For these activities, you will need the following: 4 crayons (blue, yellow, orange, and teal), a marker or pen, and a yellow dot marker or crayon.



## How to Play “Spot and Color”

Have your child color the letters with the corresponding color from the color key. Note that both forms of lowercase letter G will be colored the same color.

## How to Play “Gather the Balloons”

Using a marker or pen, have your child navigate through the maze by following the balloons marked with the different forms of lowercase letter G.

## How to Play “Cupcake Match”

Using the cupcake frosting design as a guide, have your child put the cupcakes together, matching the right and left halves.

## How to Play “Decorate the Party Hat”

Have your child fill in the lowercase letter G dots with a yellow dot marker or crayon. Your child may wish to fill in all the other dots with a different color.

# Spot and Color

Color the lowercase letters as indicated in the color key below.

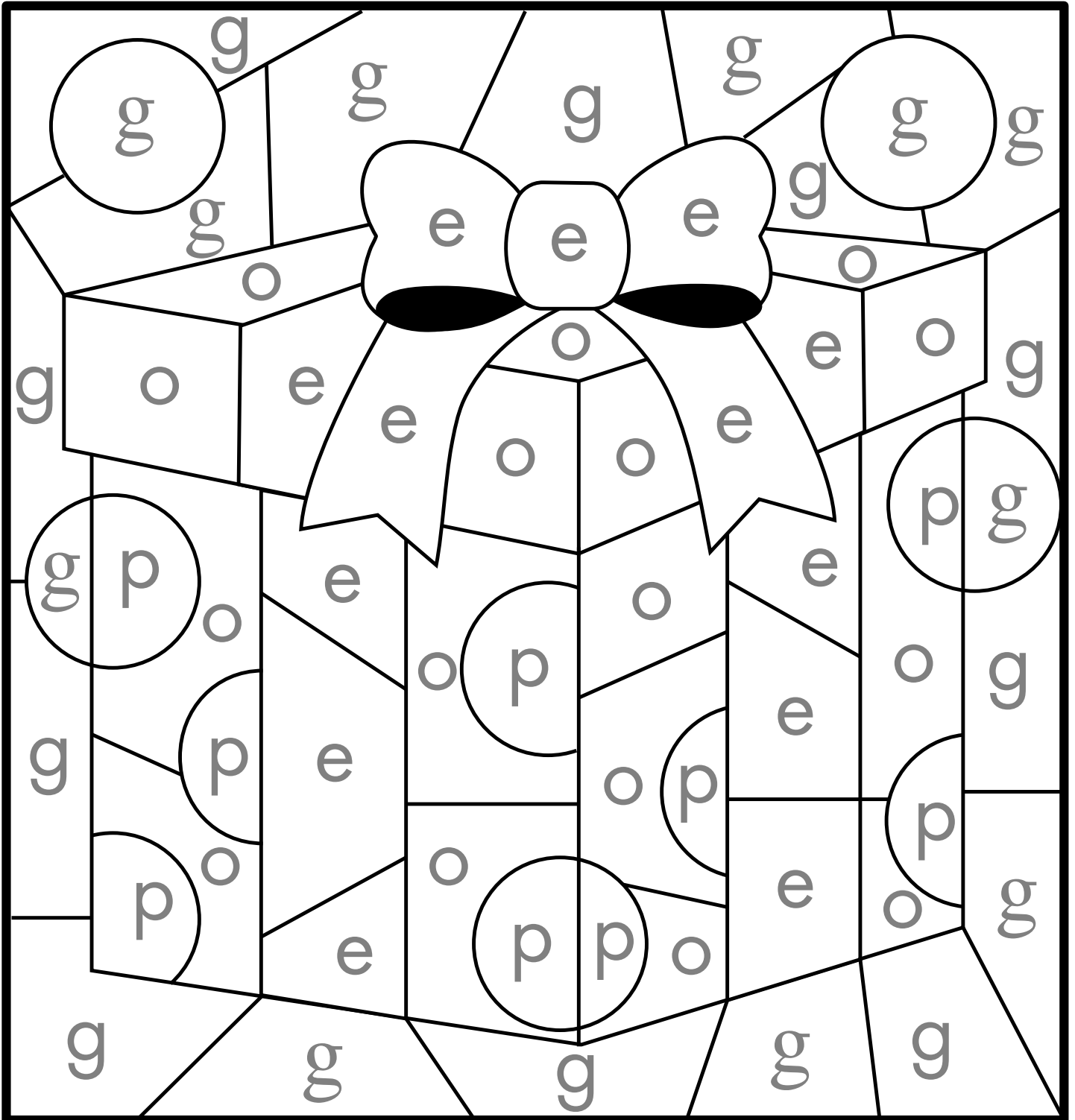



# Cupcake Match

Cut out the cupcake halves and mix them up.

Put the cupcakes together, matching the right and left sides.



# Decorate the Party Hat

Decorate the party hat by using a yellow dot marker or crayon to fill in the letter G dots.

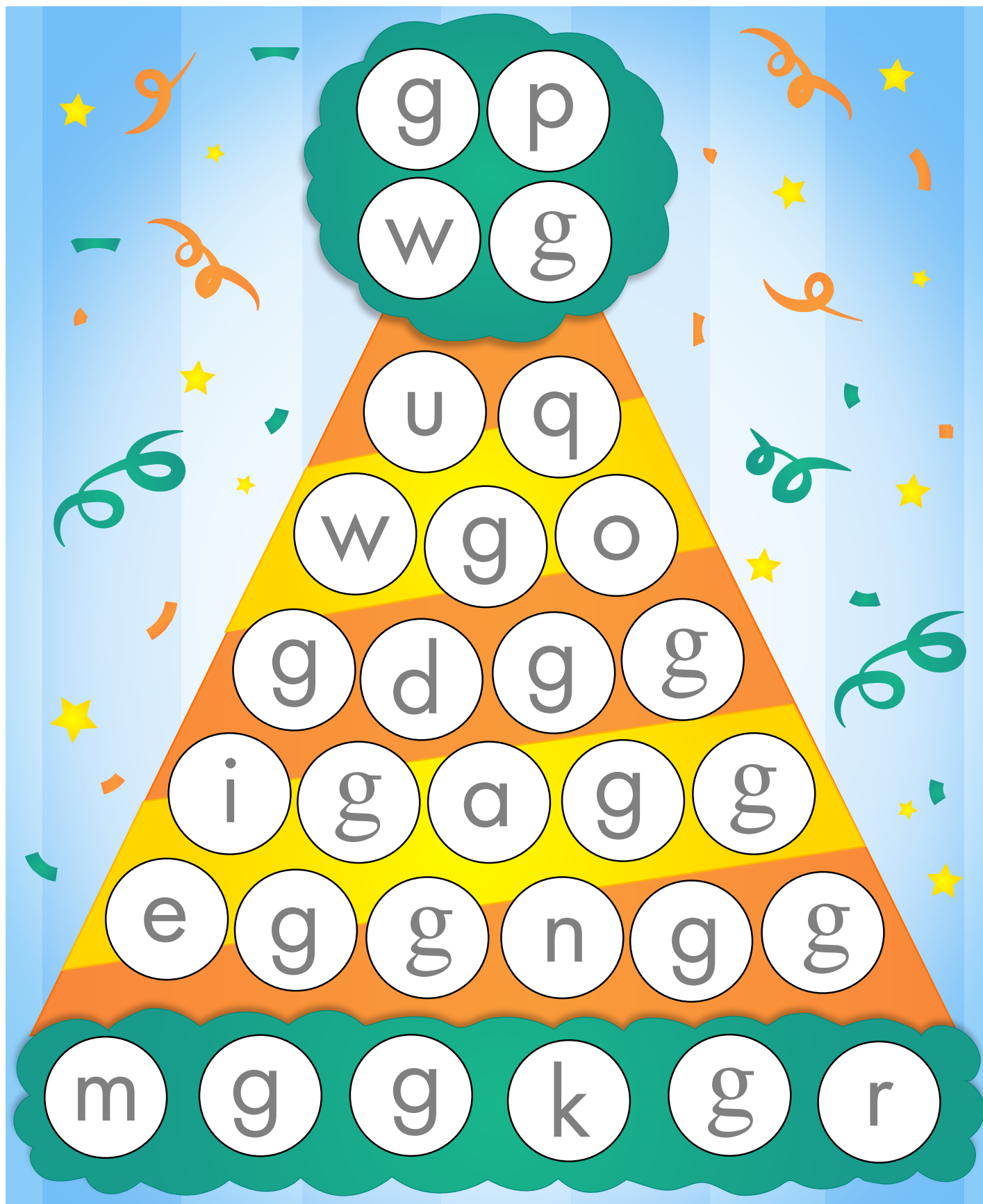



# Spot and Color

Color the lowercase letters as indicated in the color key below.

**g** | blue | 

**p** | yellow | 

**o** | orange | 

**e** | teal | 

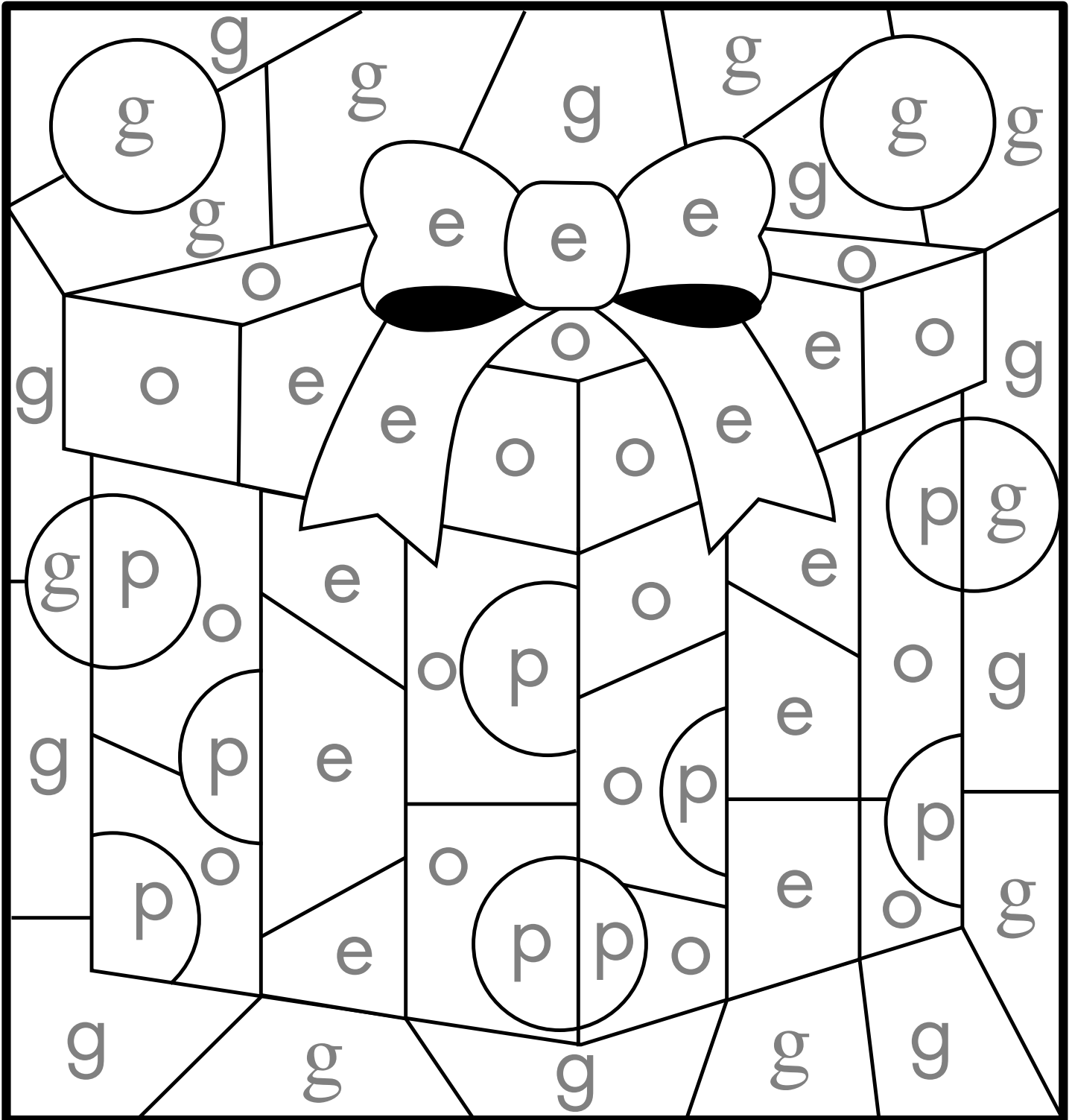



# Cupcake Match

Cut out the cupcake halves and mix them up.

Put the cupcakes together, matching the right and left sides.



# Decorate the Party Hat

Decorate the party hat by using a yellow dot marker or crayon to fill in the letter G dots.

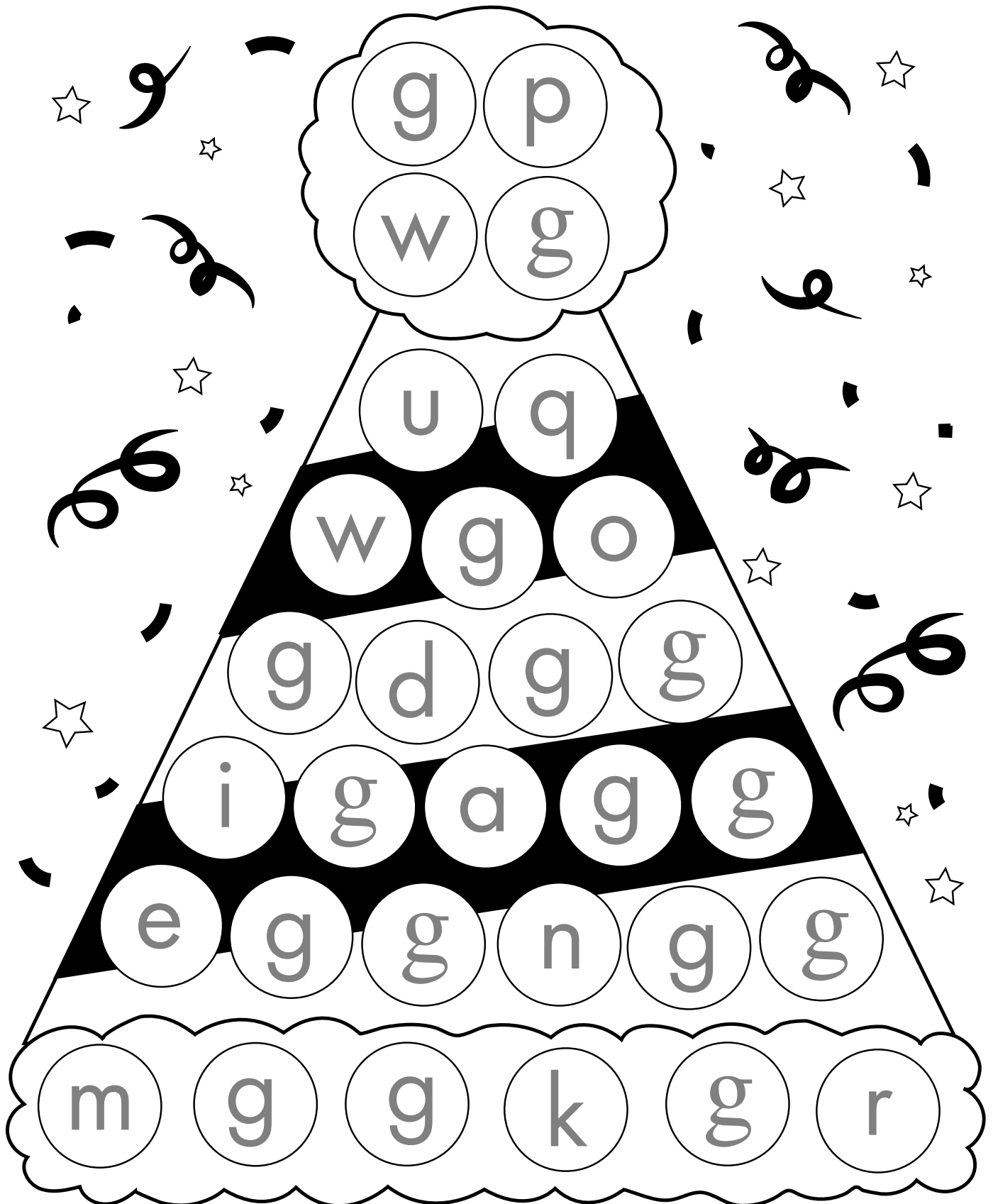

# Tricky Letters: Lowercase T

## Prepare the Activities

1. Print pages 22-25 (color) or 26-29 (black-and-white).
2. Cut out the pieces from page 24 (color) or page 28 (black-and-white). Mix up the pieces and set aside.
3. For these activities, you will need the following:  
4 crayons (light green, brown, green, and blue), a marker or pen, and a green dot marker or crayon.



## How to Play “Spot and Color”

Have your child color the letters with the corresponding color from the color key. Note that both forms of lowercase letter T will be colored the same color.

## How to Play “Lily Pad Hop”

Using a marker or pen, have your child navigate through the maze by following the lily pads marked with the different forms of lowercase letter T.

## How to Play “Butterfly Match”

Using the unique design on the butterfly wings as a guide, have your child put the butterflies together, matching the right and left sides.

## How to Play “Add the Tadpoles”

Have your child fill in the lowercase letter T dots with a green dot marker or crayon. Your child may wish to fill in all the other dots with a different color.

# Spot and Color

Color the lowercase letters as indicated in the color key below.

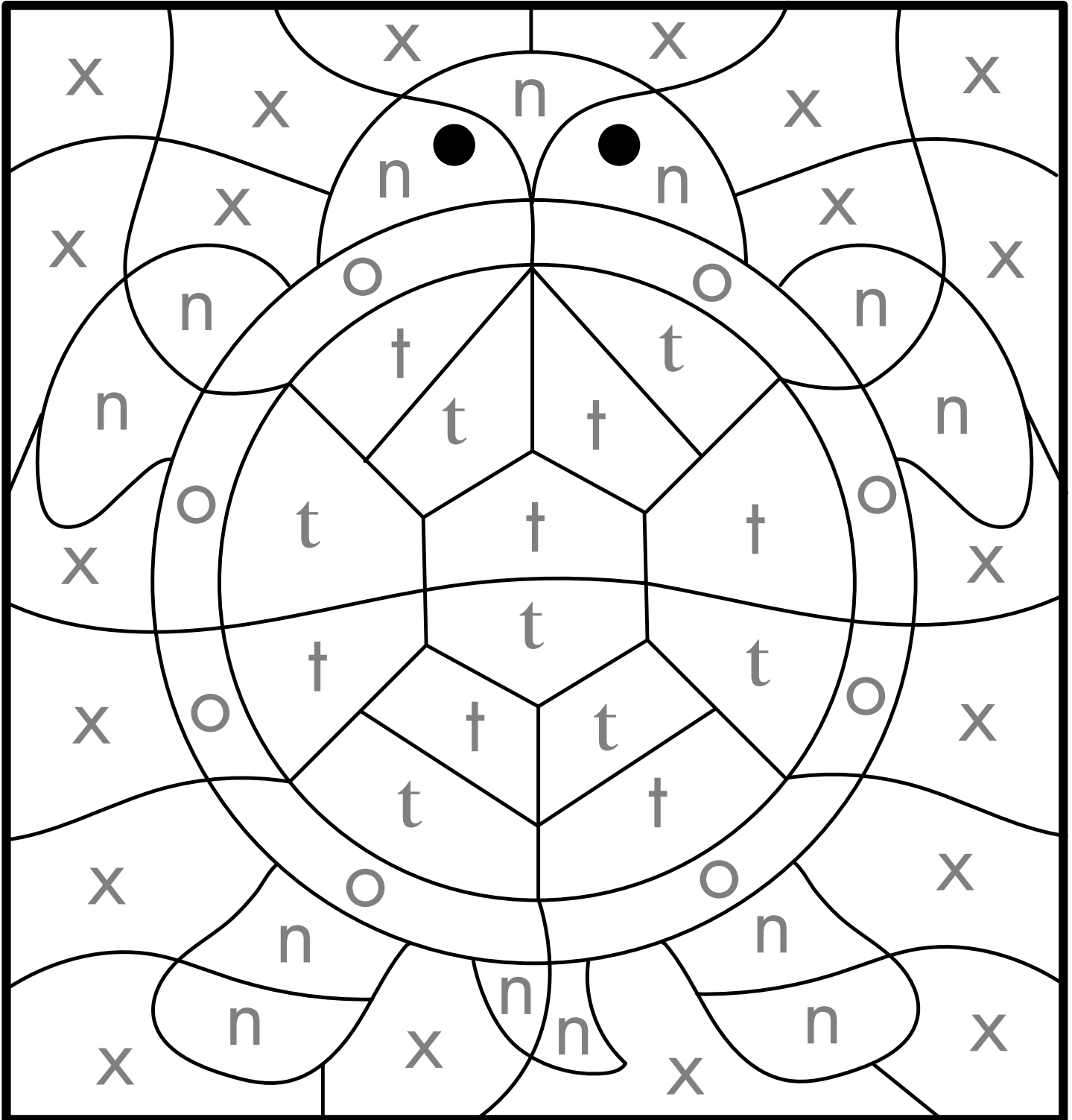



# Lily Pad Hop

Help the frog get to the other side of the pond by hopping only on the lowercase letter T lily pads.

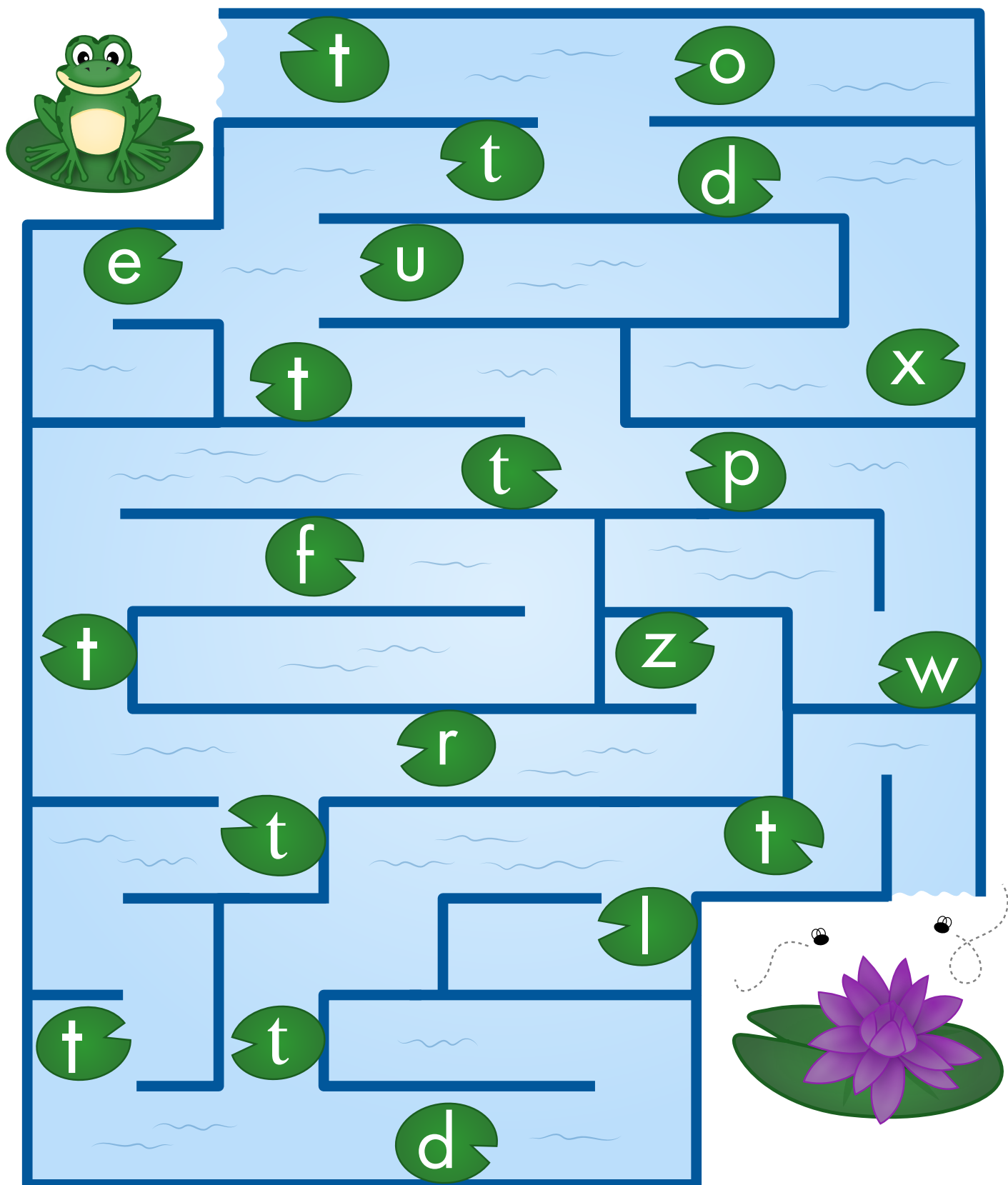

# Butterfly Match

Cut out the butterfly pieces and mix them up.  
Put the butterflies together, matching the right and left sides.



# Add the Tadpoles

Add some tadpoles to the pond by using a green dot marker or crayon to fill in the letter T dots.

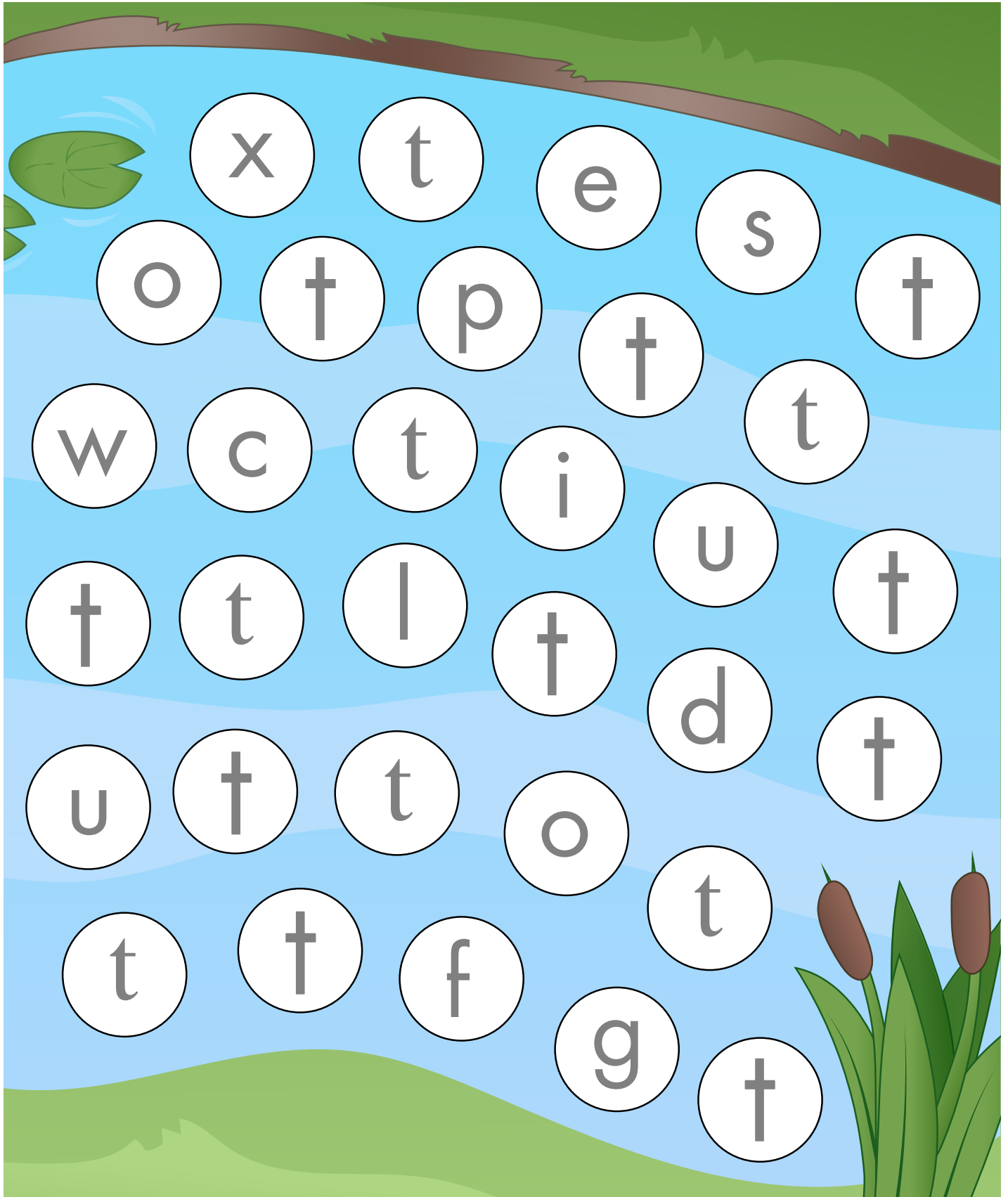

# Spot and Color

Color the lowercase letters as indicated in the color key below.

**t** light green

**o** brown

**n** green

**x** blue

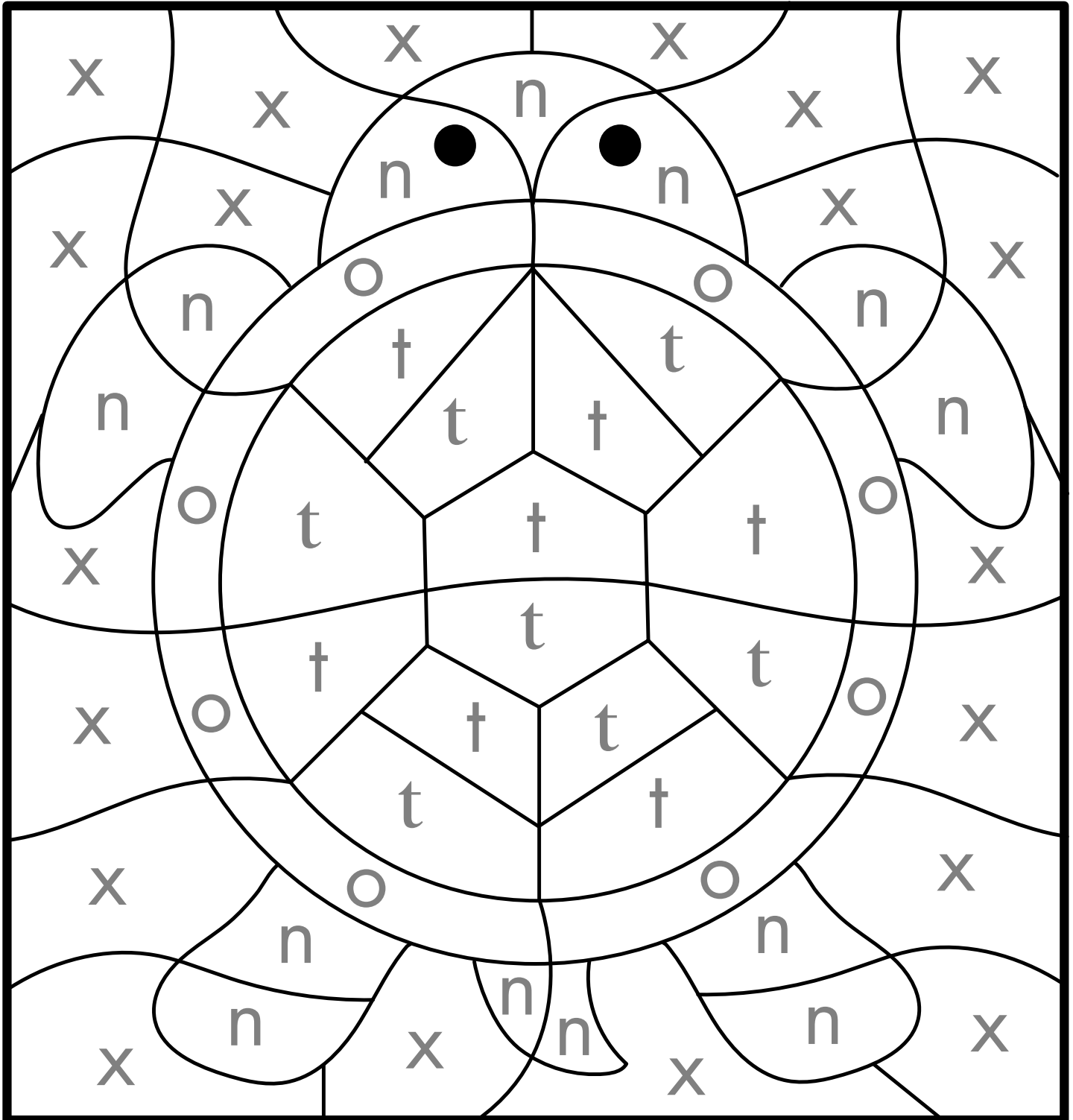

# Lily Pad Hop

Help the frog get to the other side of the pond by hopping only on the lowercase letter T lily pads.

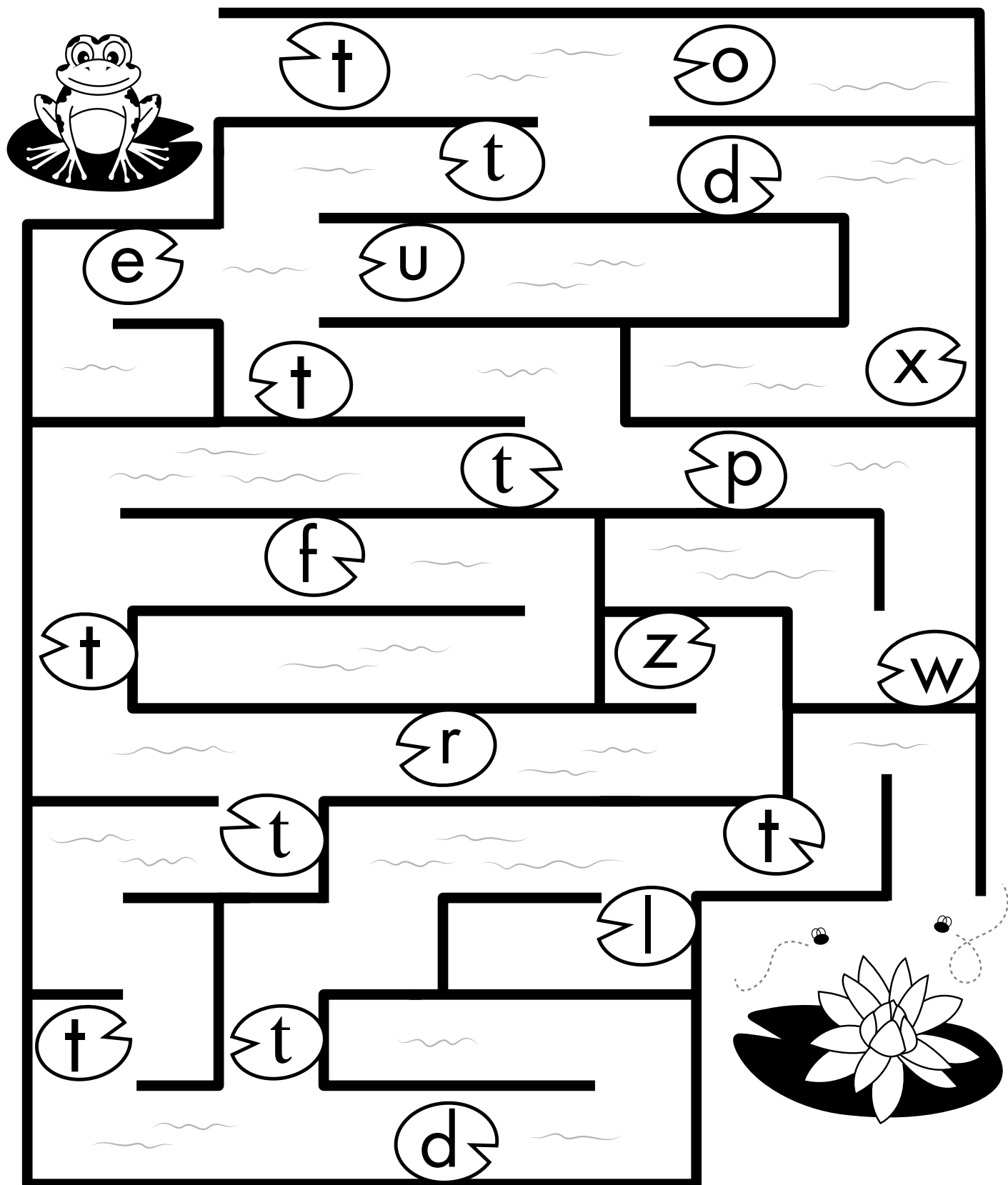

# Butterfly Match

Cut out the butterfly pieces and mix them up.

Put the butterflies together, matching the right and left sides.

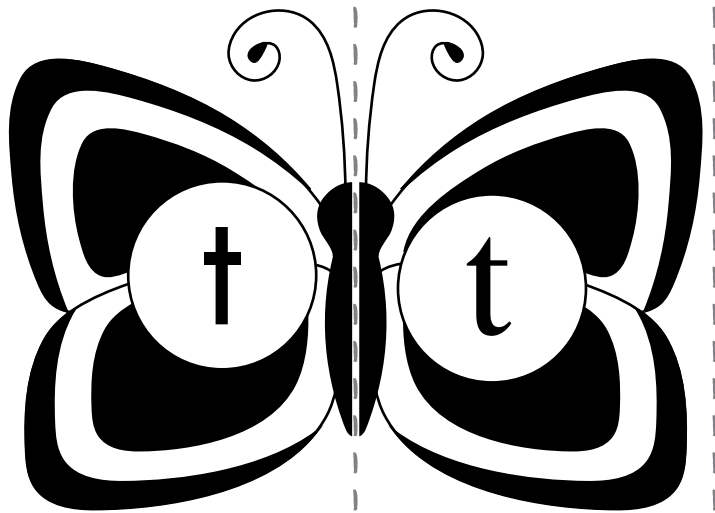
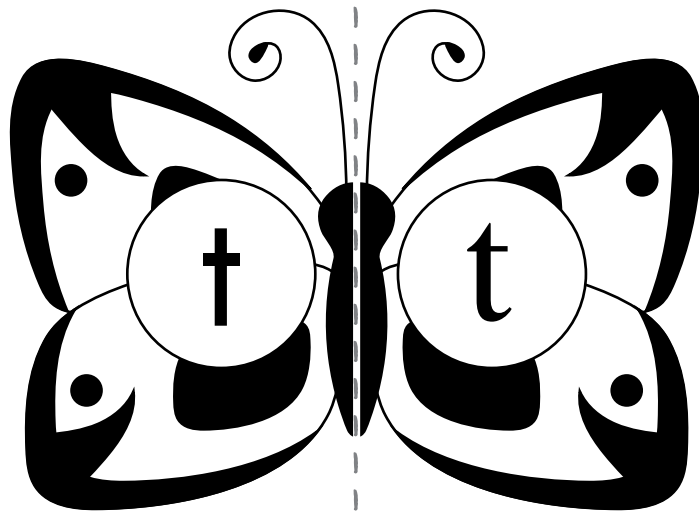
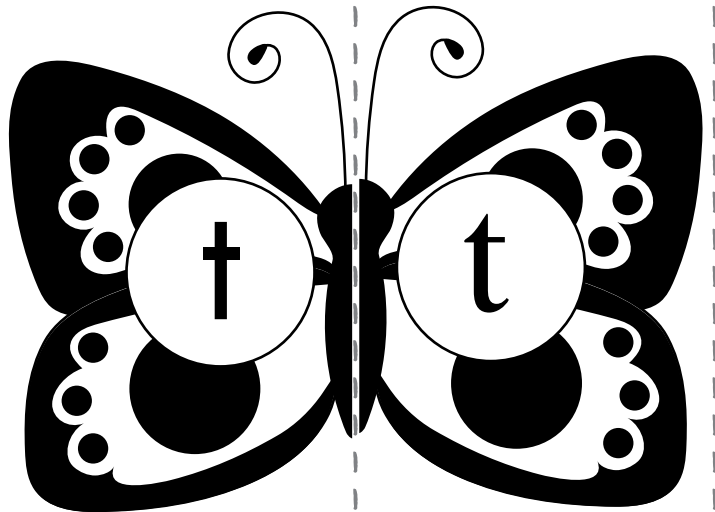
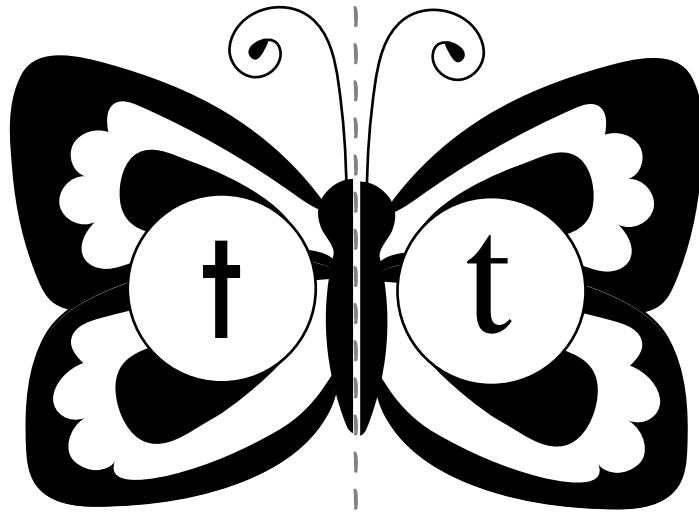
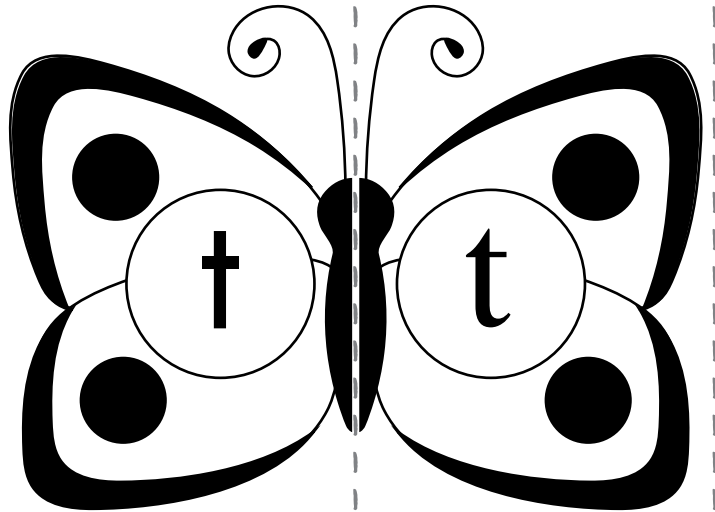
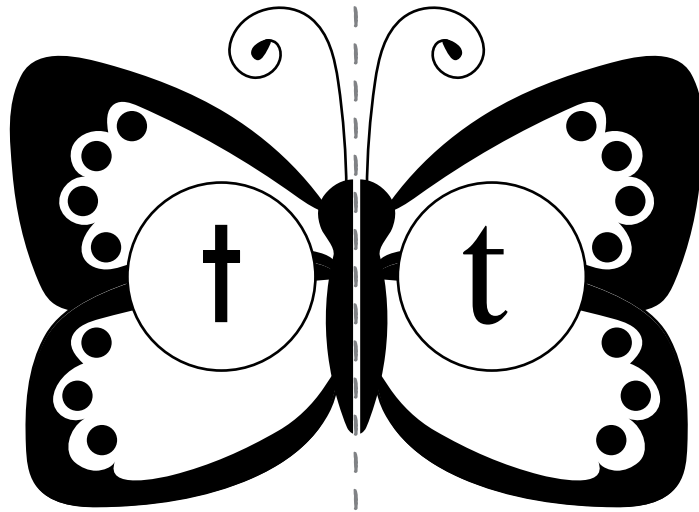



# Add the Tadpoles

Add some tadpoles to the pond by using a green dot marker or crayon to fill in the letter T dots.

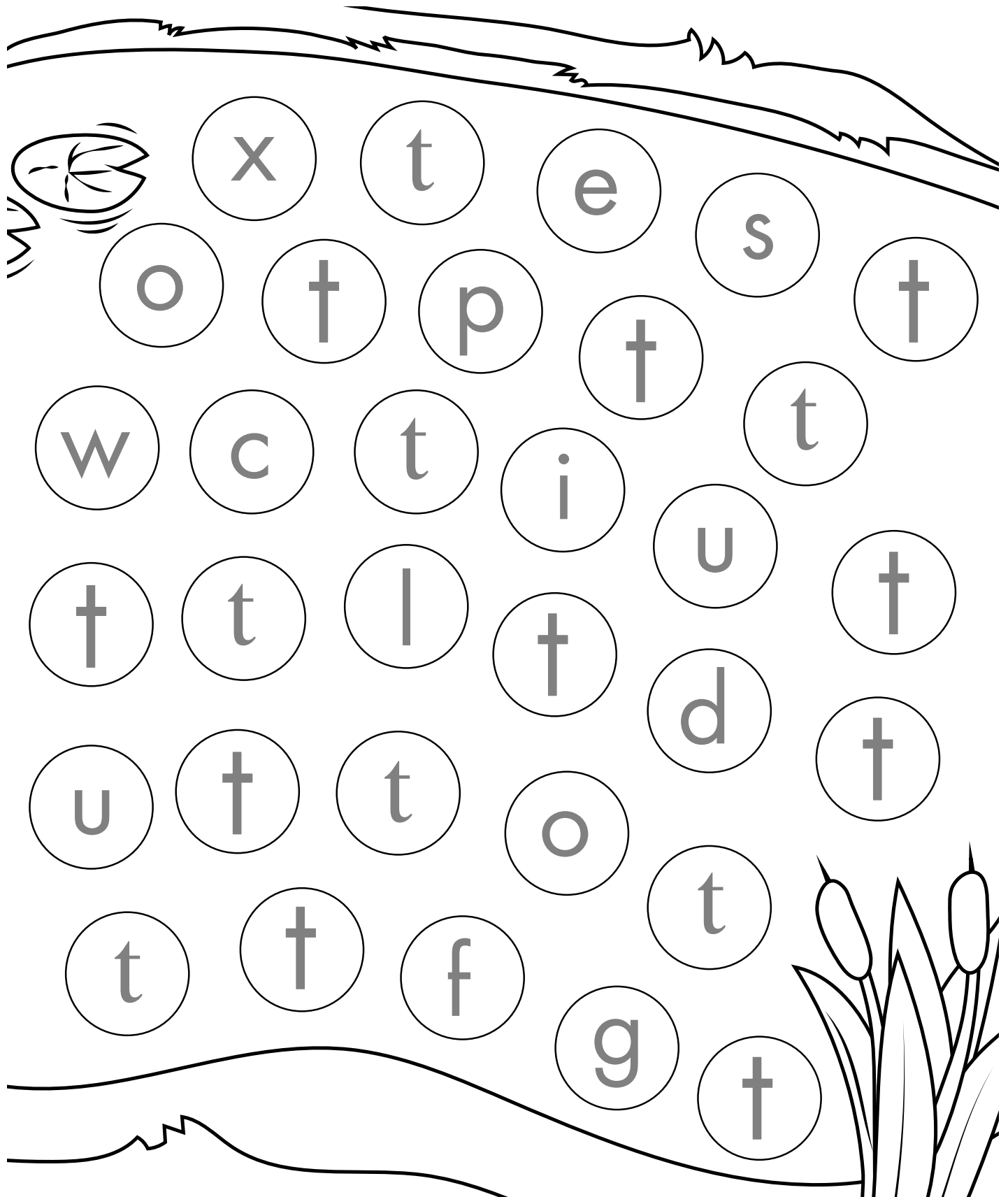

# Tricky Letters: Lowercase Q

## Prepare the Activities

1. Print pages 31-34 (color) or 35-38 (black-and-white).
2. Cut out the pieces from page 33 (color) or page 37 (black-and-white). Mix up the pieces and set aside.
3. For these activities, you will need the following: 4 crayons (blue, yellow, red, and brown), a marker or pen, and a red dot marker or crayon.



## How to Play “Spot and Color”

Have your child color the letters with the corresponding color from the color key. Note that all forms of lowercase letter Q will be colored the same color.

## How to Play “Garden Maze”

Using a marker or pen, have your child navigate through the maze by following the flowers marked with the different forms of lowercase letter Q.

## How to Play “Crown Match”

Using the design of the crown jewels as a guide, have your child put the crowns together, matching the right and left sides.

## How to Play “Add the Roses”

Have your child fill in the lowercase letter Q dots with a red dot marker or crayon. Your child may wish to fill in all the other dots with a different color.

# Spot and Color

Color the lowercase letters as indicated in the color key below.

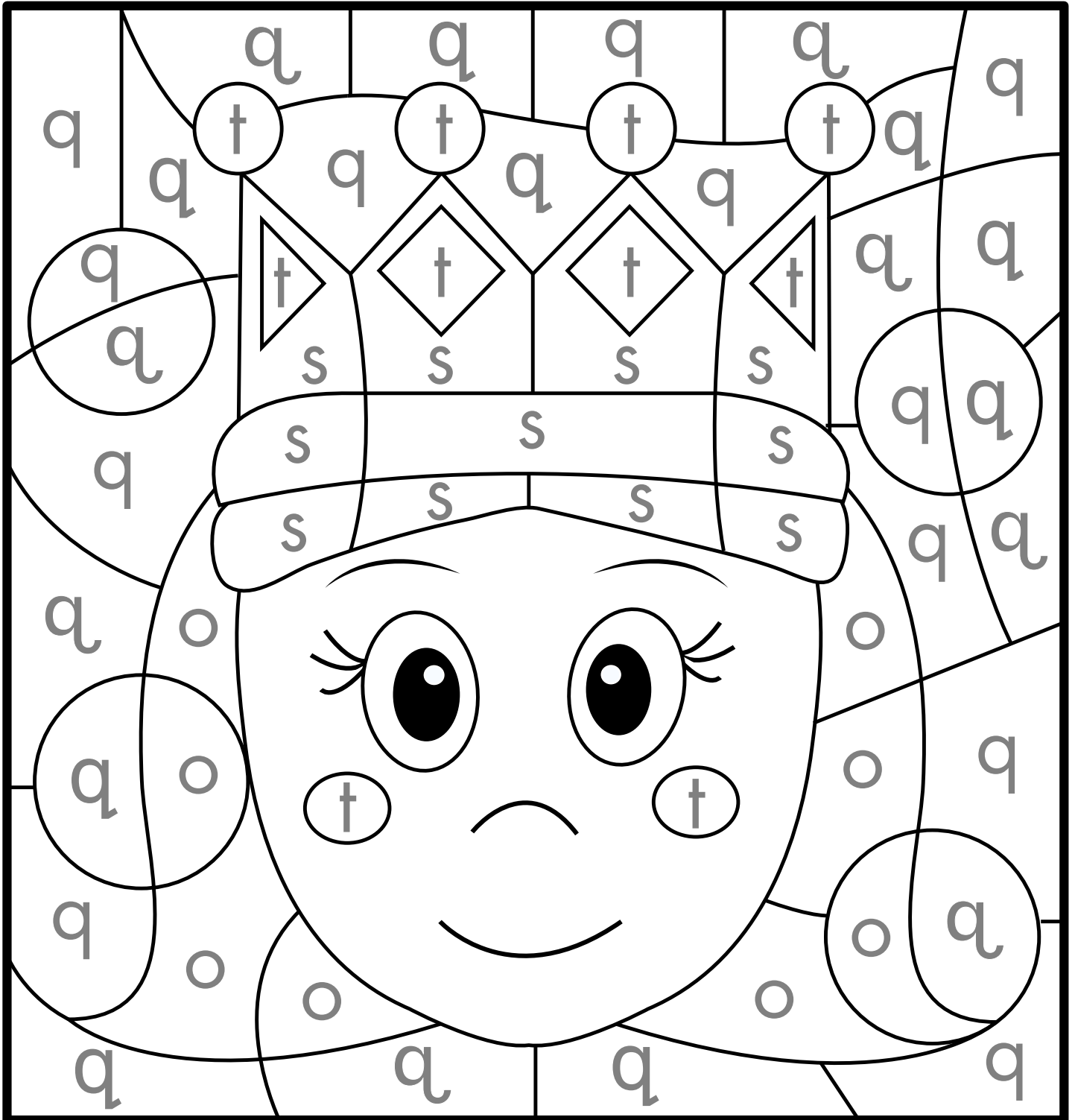



# Crown Match

Cut out the crown pieces and mix them up.  
Put the crowns together, matching the right and left sides.

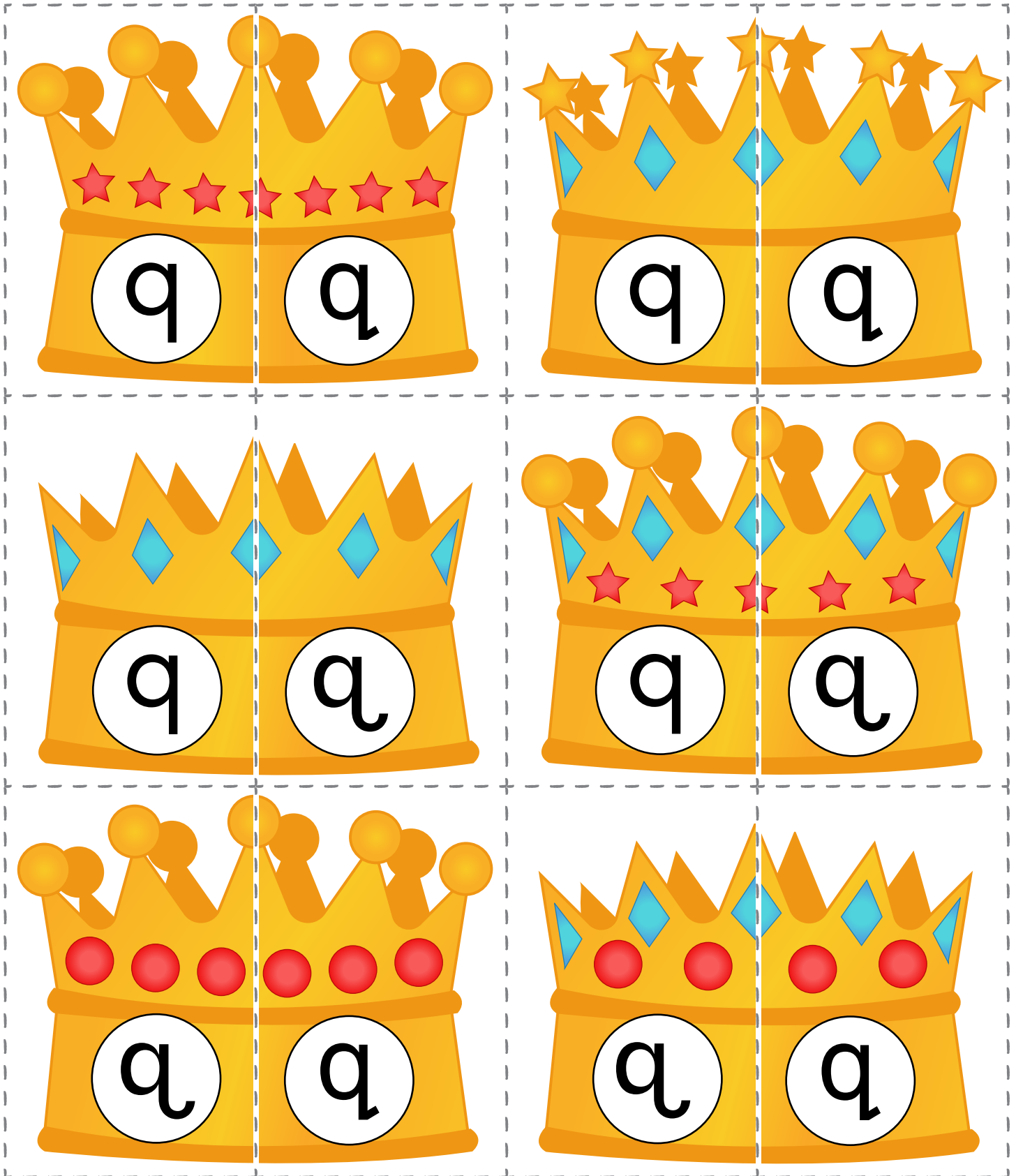

# Add the Roses

Add roses to the royal garden by using a red dot marker or crayon to fill in the letter Q dots.

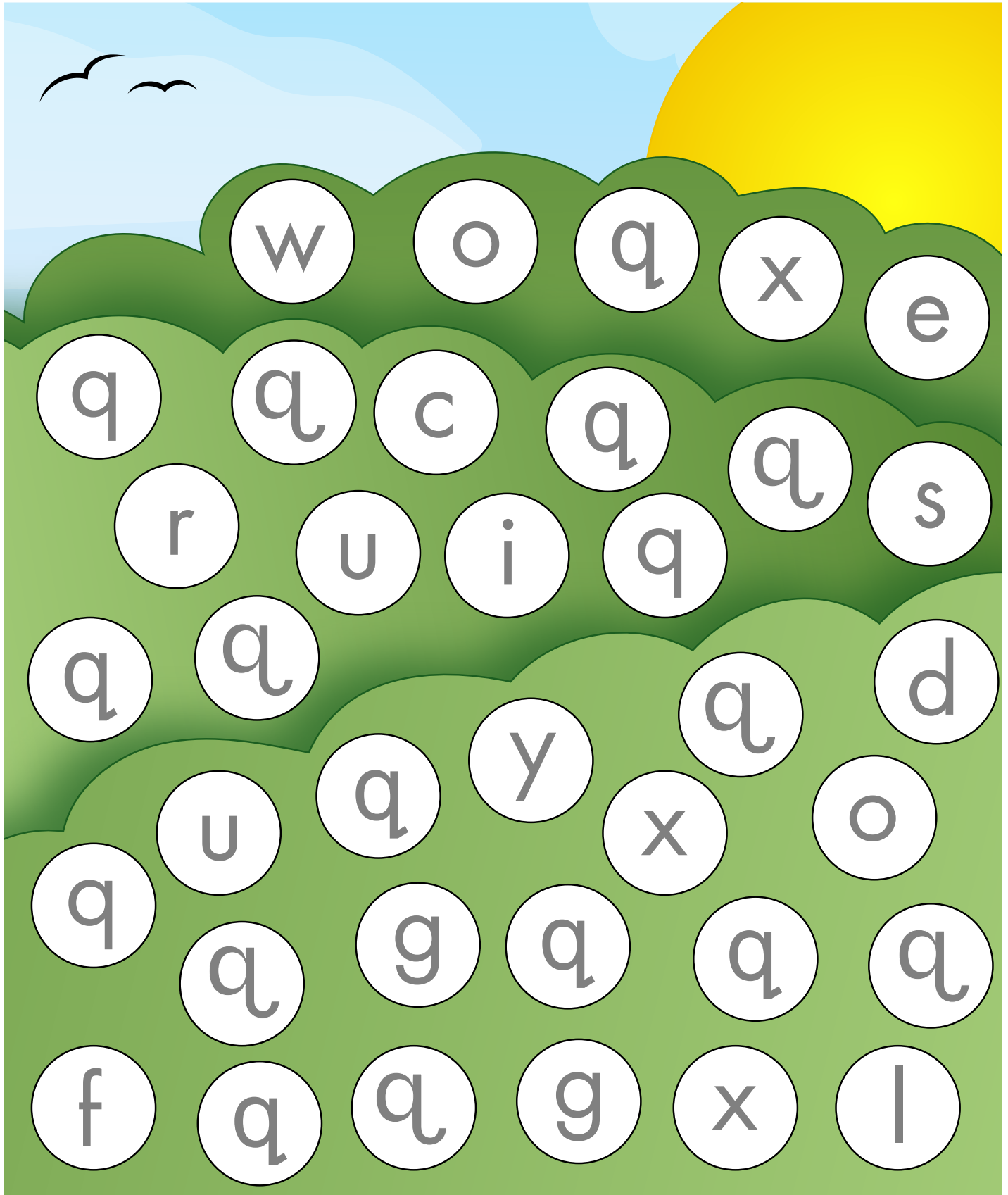

# Spot and Color

Color the lowercase letters as indicated in the color key below.

**q** | blue

**s** | yellow

**o** | brown

**t** | red

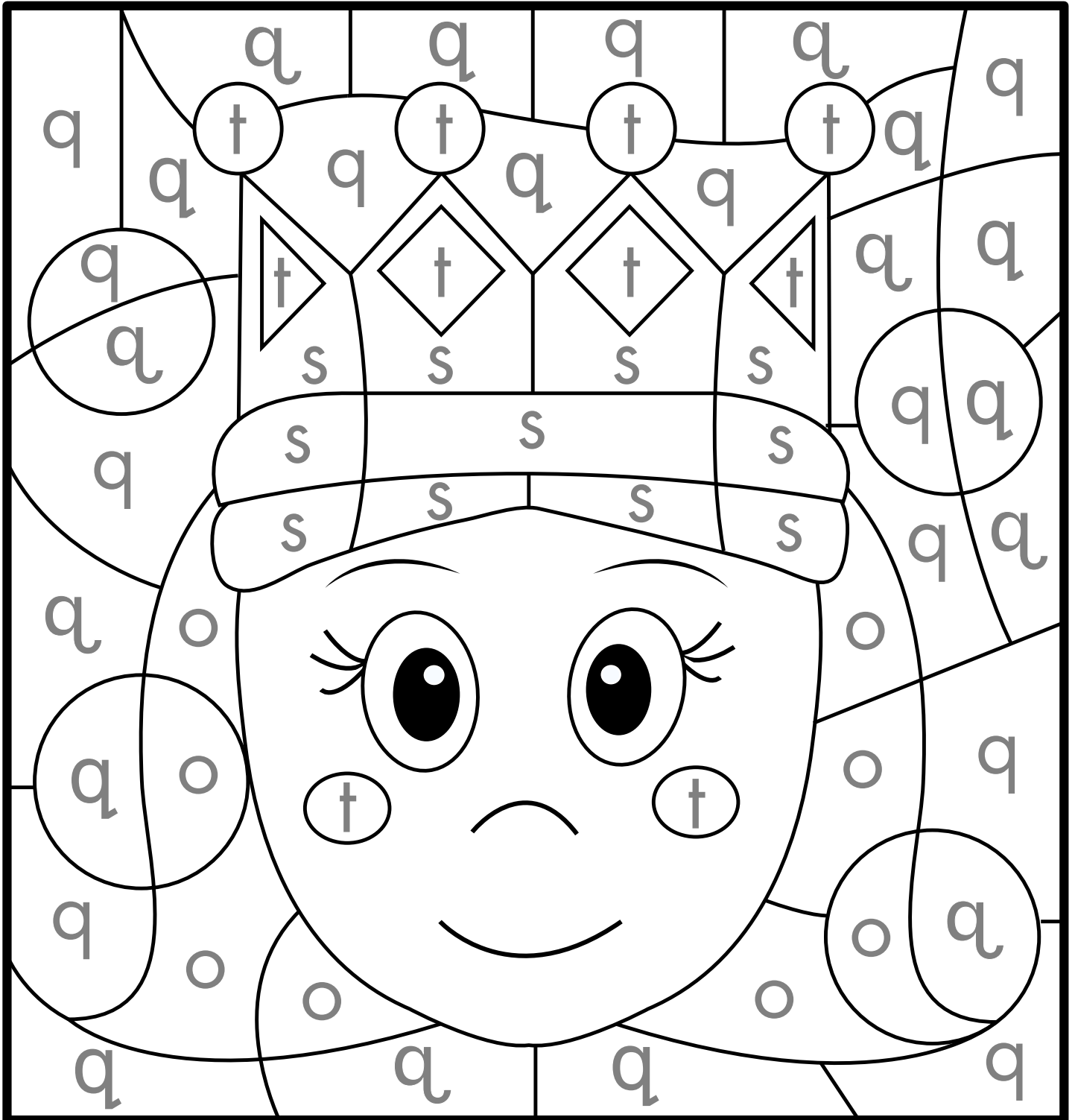





# Crown Match

Cut out the crown pieces and mix them up.  
Put the crowns together, matching the right and left sides.

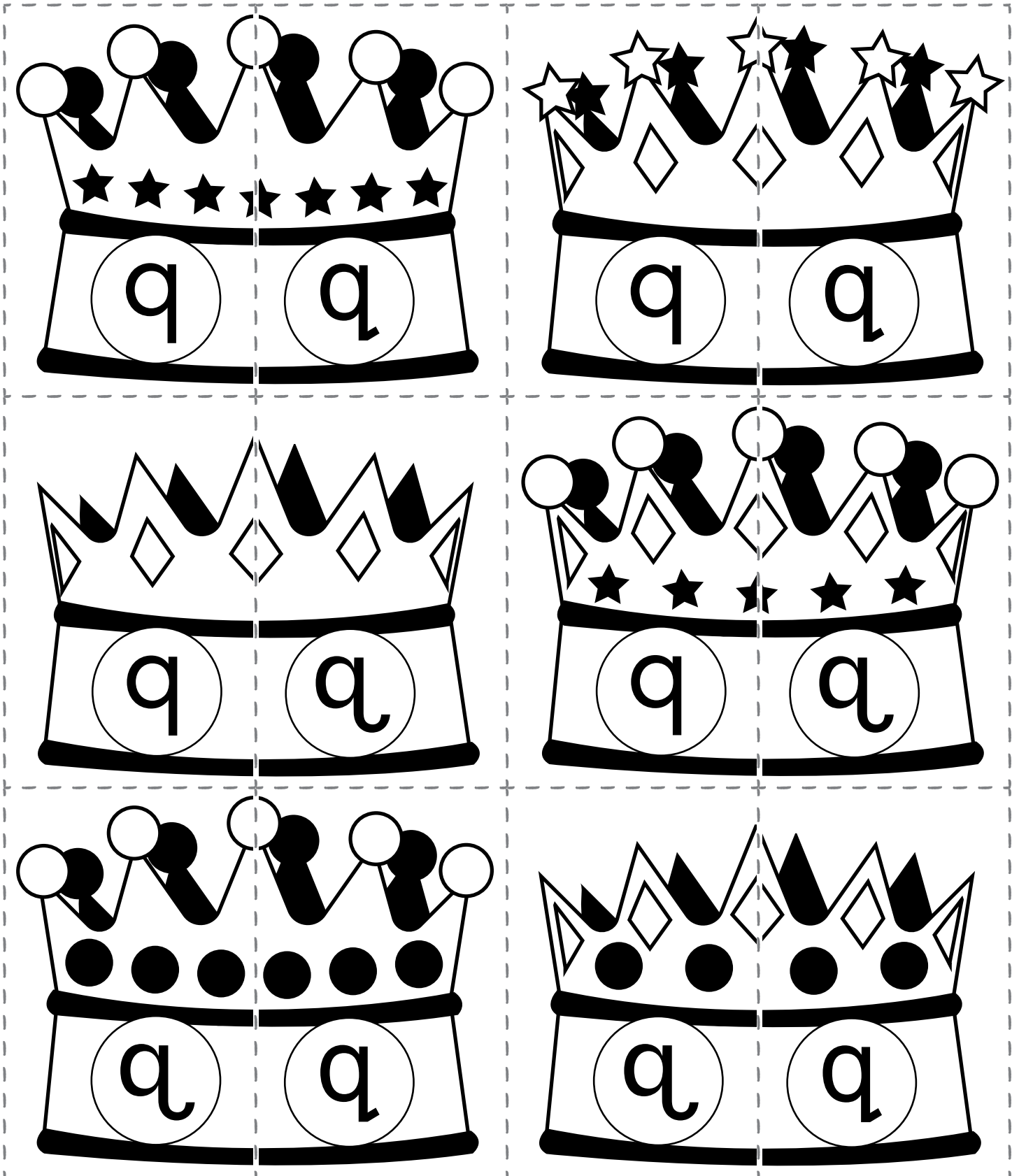

# Add the Roses

Add roses to the royal garden by using a red dot marker or crayon to fill in the letter Q dots.

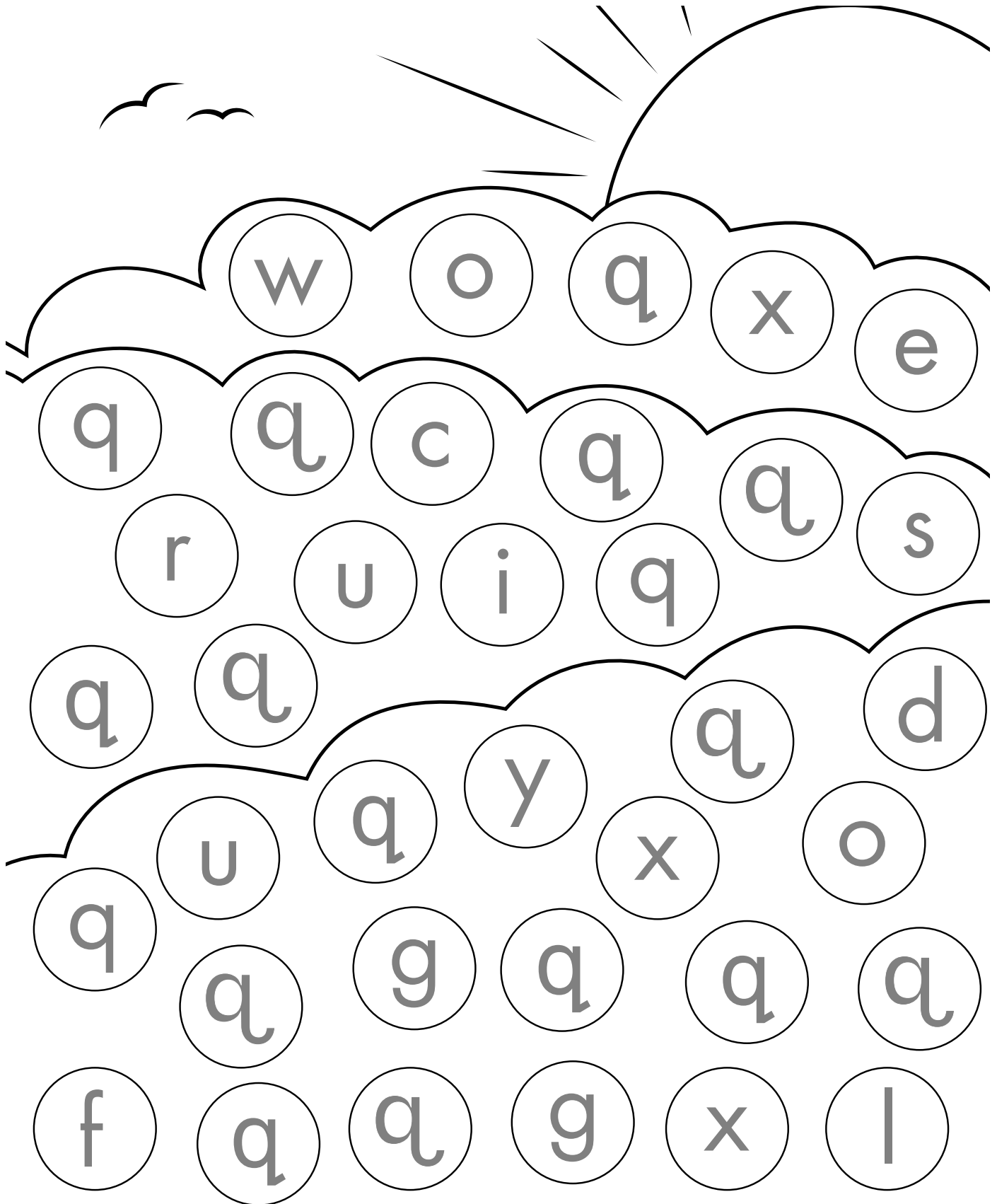

# Tricky Letters: Lowercase Y

## Prepare the Activities

1. Print pages 40-43 (color) or 44-47 (black-and-white).
2. Cut out the pieces from page 42 (color) or page 46 (black-and-white). Mix up the pieces and set aside.
3. For these activities, you will need the following: 4 crayons (red, yellow, green, and blue), a marker or pen, and a blue dot marker or crayon.



## How to Play “Spot and Color”

Have your child color the letters with the corresponding color from the color key. Note that all forms of lowercase letter Y will be colored the same color.

## How to Play “Lost in Space”

Using a marker or pen, have your child navigate through the maze by following the stars marked with different forms of lowercase letter Y.

## How to Play “Block Match”

Using the color and shape of the blocks as a guide, have your child put the blocks together, matching the right and left sides.

## How to Play “Dot the Gumballs”

Have your child fill in the lowercase letter Y dots with a blue dot marker or crayon. Your child may wish to fill in all the other dots with a different color.

# Spot and Color

Color the lowercase letters as indicated in the color key below.

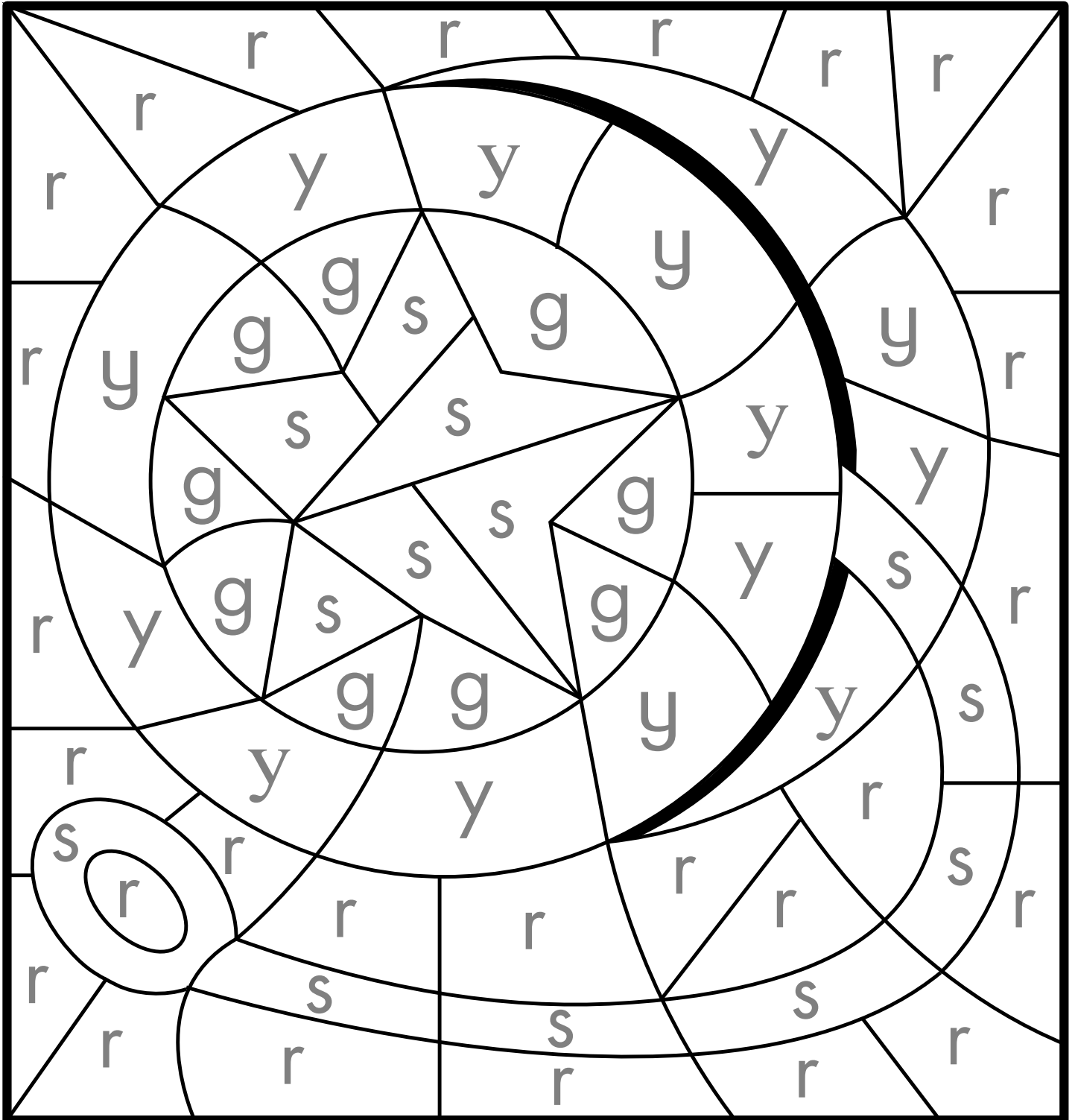



# Block Match

Cut out the blocks and mix them up.

Put the blocks together, matching the right and left sides.

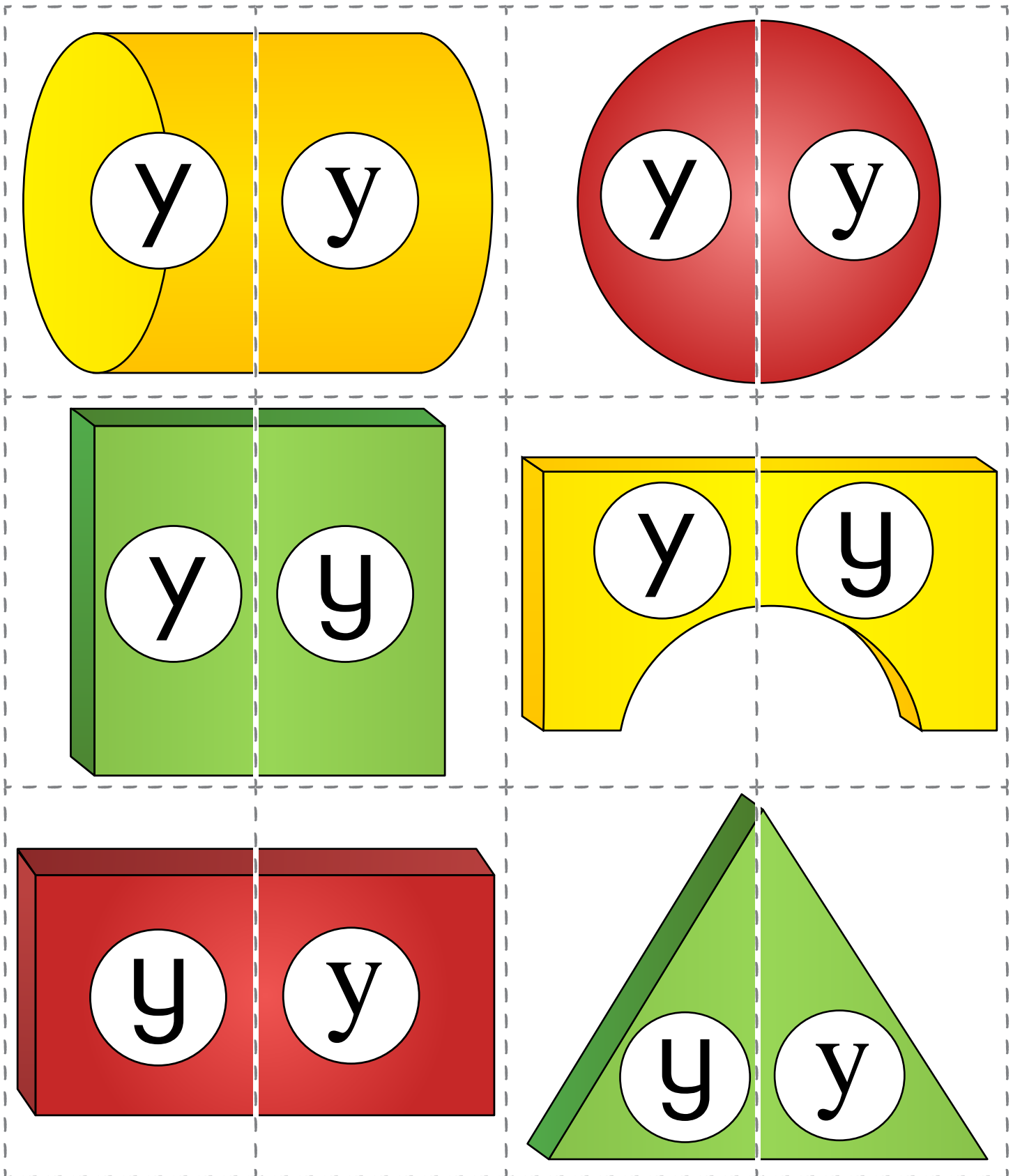

# Dot the Gumballs

Add some gumballs by using a blue dot marker or crayon to fill in the letter Y dots.



# Spot and Color

Color the lowercase letters as indicated in the color key below.

**y** | red |

**s** | yellow |

**g** | green |

**r** | blue |

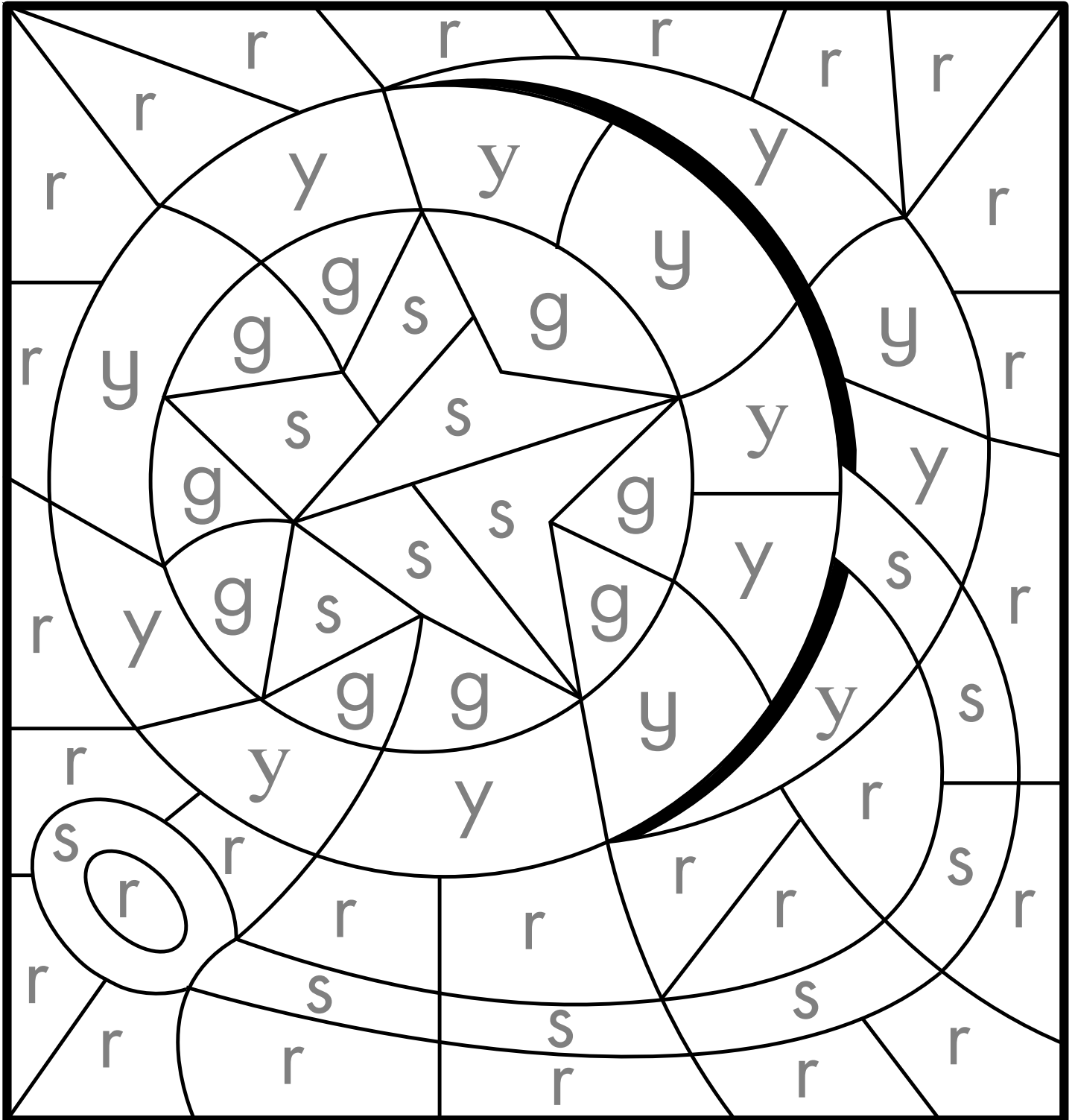





# Block Match

Cut out the blocks and mix them up.

Put the blocks together, matching the right and left sides.

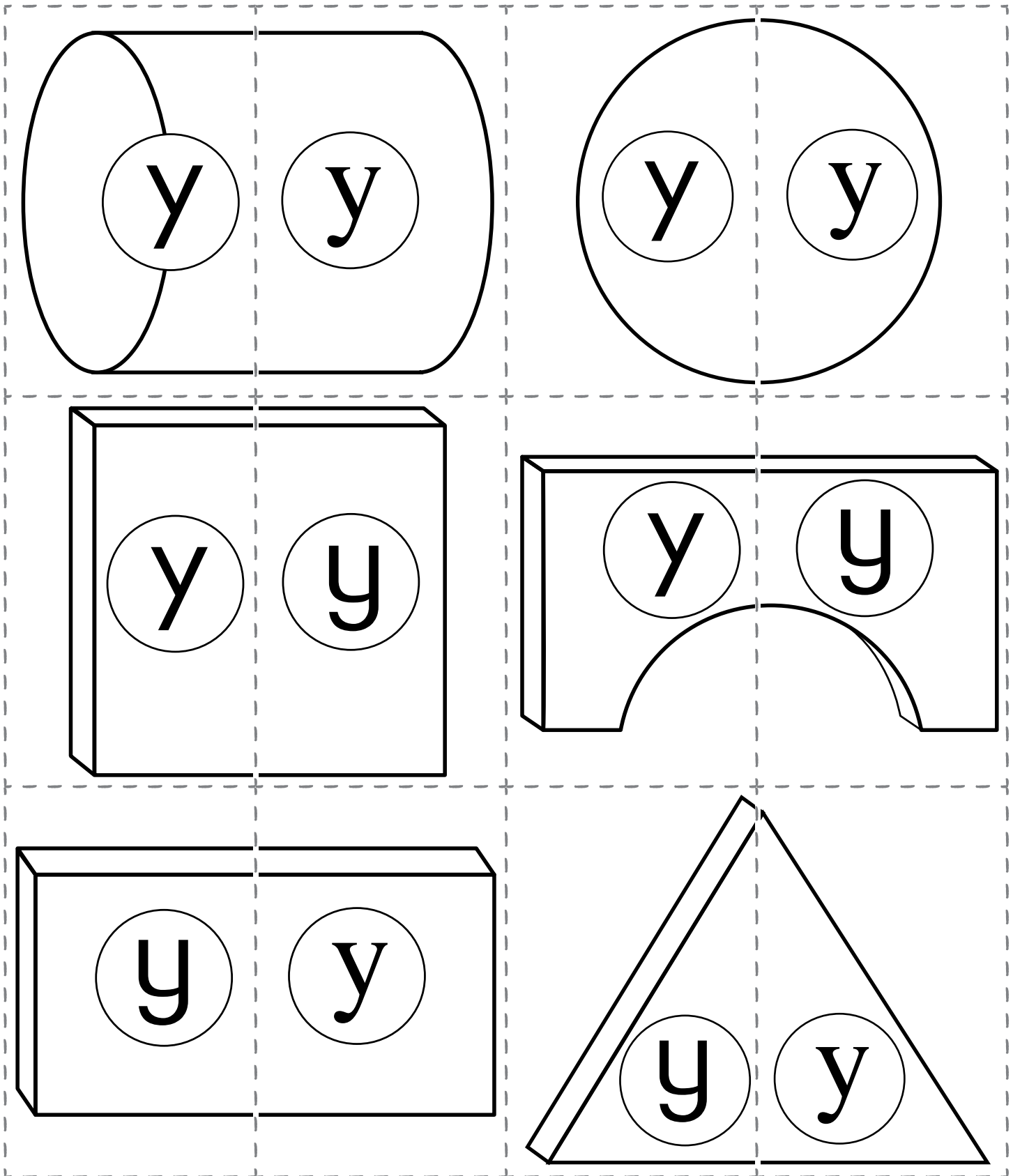

# Dot the Gumballs

Add some gumballs by using a blue dot marker or crayon to fill in the letter Y dots.





# ALL ABOUT<sup>®</sup> Reading

The program that takes the struggle out of reading

## Did you enjoy this activity? Then you'll love **All About<sup>®</sup> Reading Pre-reading!**

The *All About Reading* Pre-reading program is designed for preschoolers and kindergarteners. Your student will enjoy the special games, crafts, and storytime read-alouds, and you will love the way your student effortlessly learns the five essential pre-reading skills:

- Print Awareness
- Letter Knowledge
- Phonological Awareness
- Listening Comprehension
- Motivation to Read



To learn more about **All About<sup>®</sup> Reading Pre-reading**, please visit  
[www.AllAboutReading.com](http://www.AllAboutReading.com)  
or call us at 715-477-1976.